

[BASE & FLANGE]

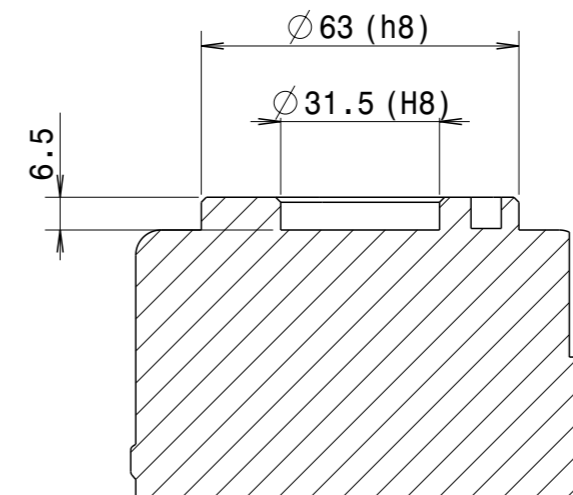
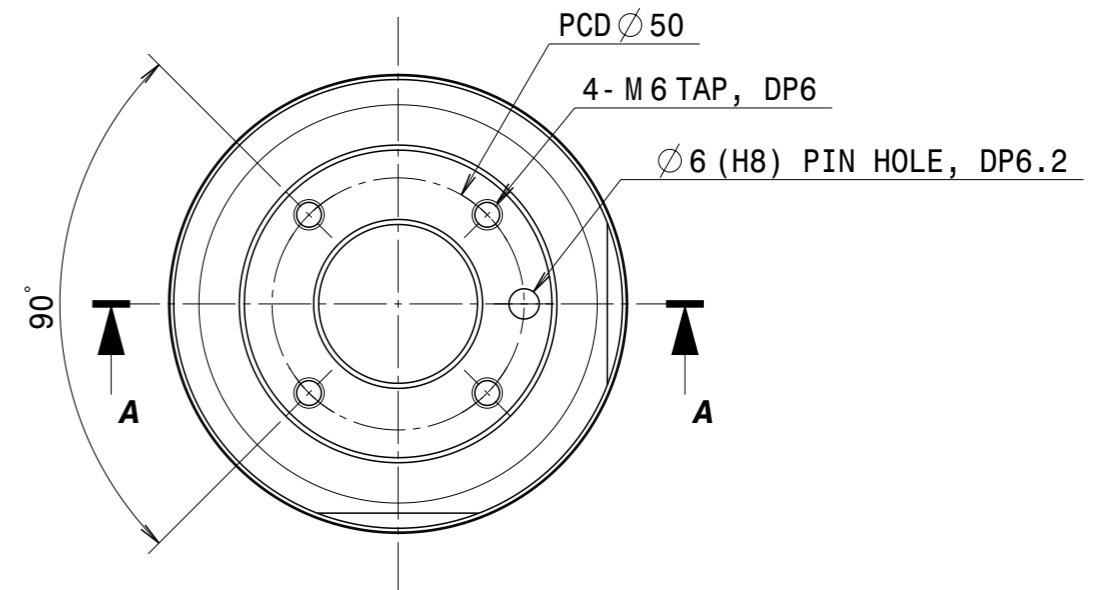
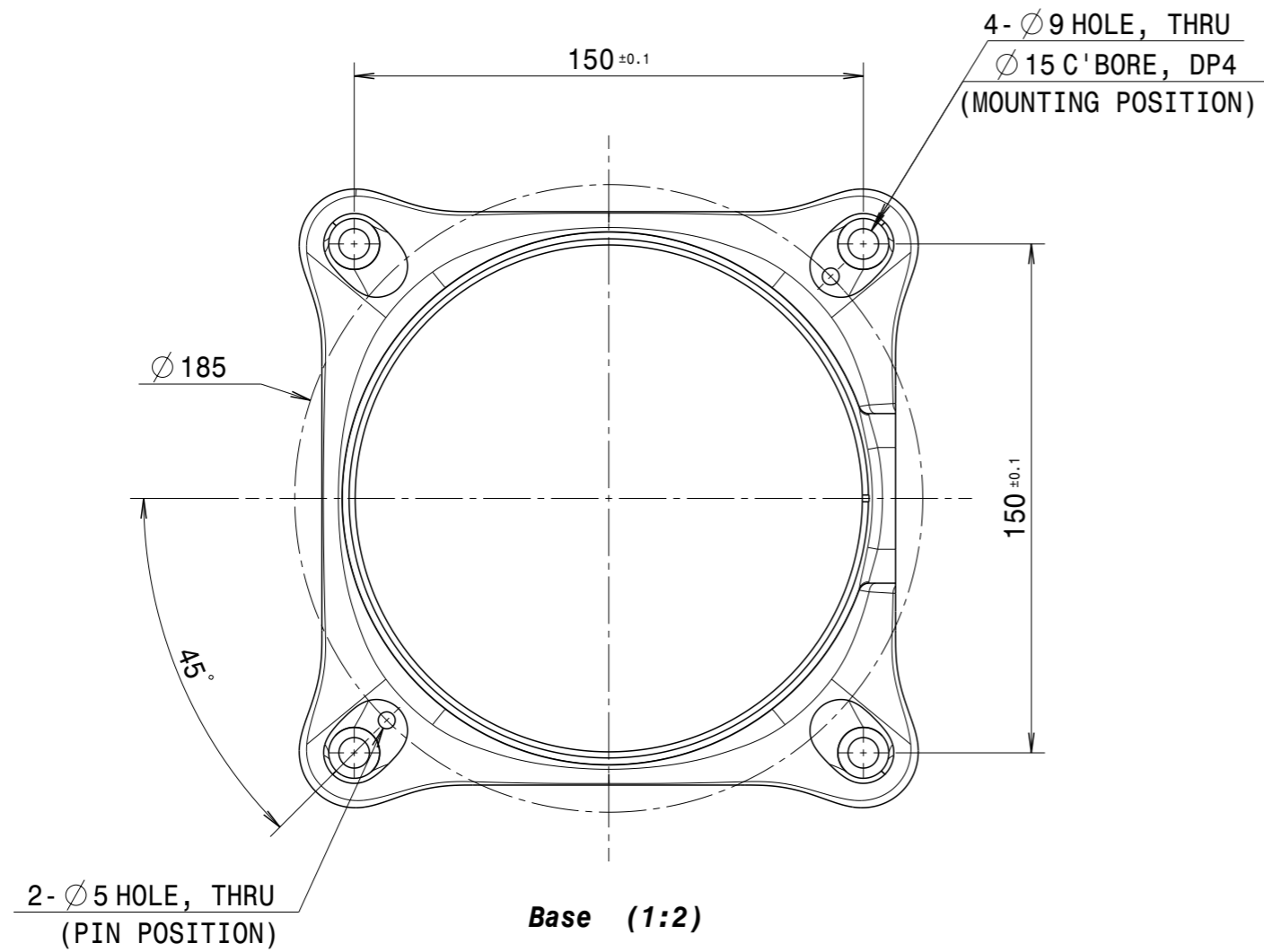

JOINT RANGE	
AXIS	WORKING AREA (SOFTWARE LIMIT) / DEGREE
1	-360 ~ 360
2	-360 ~ 360
3	-150 ~ 150
4	-360 ~ 360
5	-360 ~ 360
6	-360 ~ 360
PAYLOAD	15kg
REACH	900mm

TITLE	LAYOUT		Q'TY	1
MODEL	M1509		W.T (kg)	32
SERIES	MAT.		SCALE	
M-SERIES	DRG. NO.	A3		
DATE	21.03.03			
		DOOSAN		