

[BASE & FLANGE]

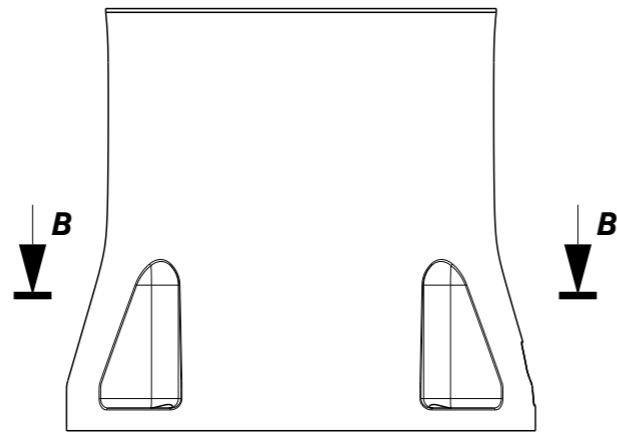

Base (1:4)

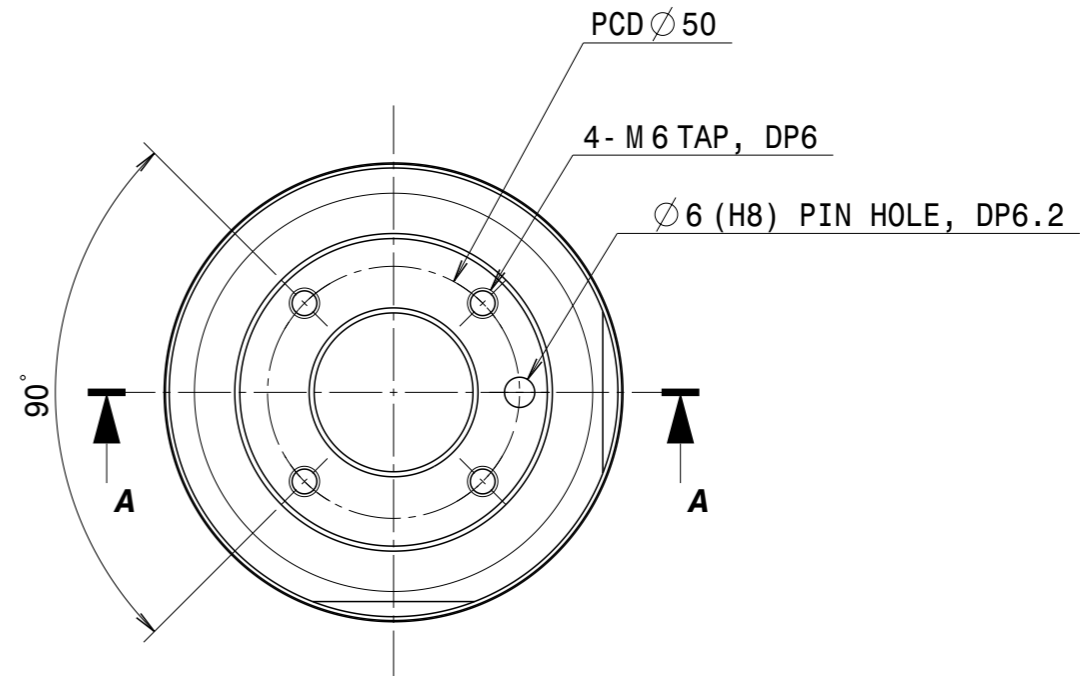

Tool Flange (2:3)

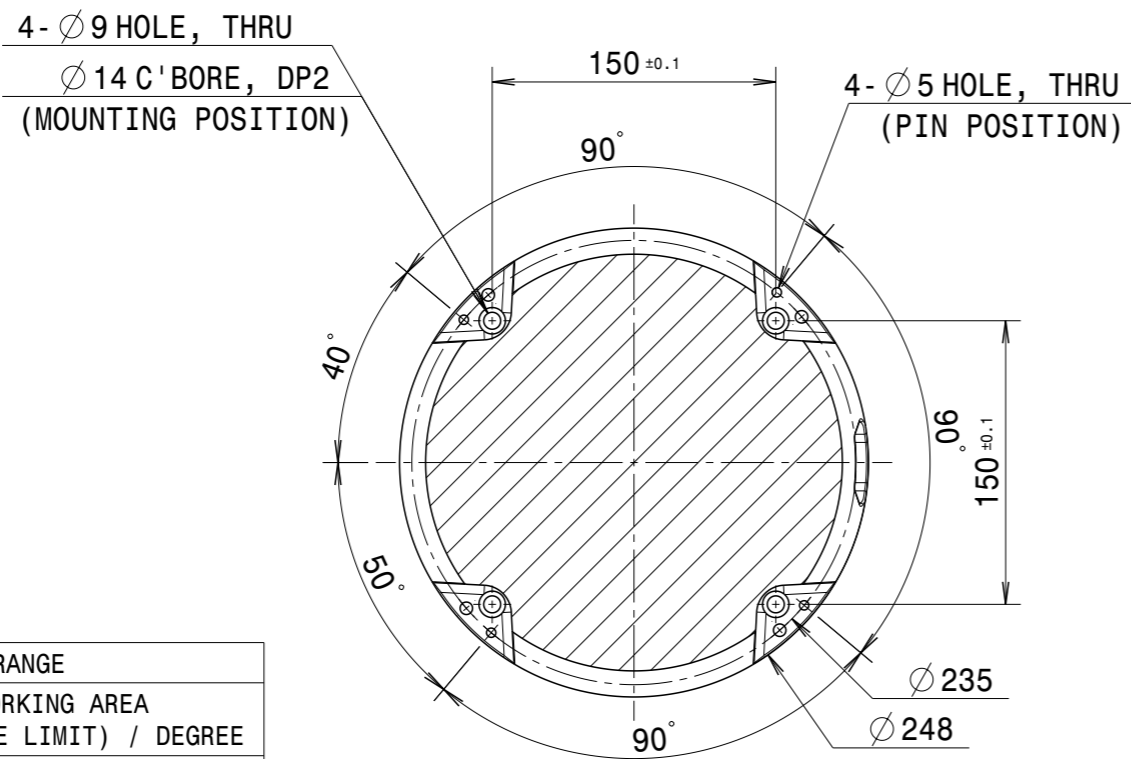

Section view B-B (1:4)

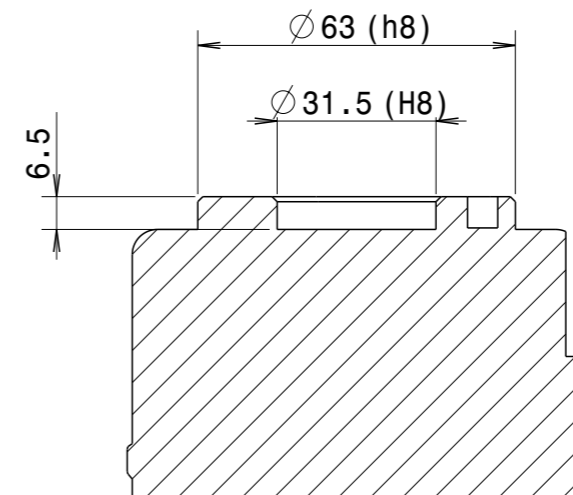

Section view A-A (2:3)

JOINT RANGE	
AXIS	WORKING AREA (SOFTWARE LIMIT) / DEGREE
1	-360 ~ 360
2	-125 ~ 125
3	-160 ~ 160
4	-360 ~ 360
5	-360 ~ 360
6	-360 ~ 360
PAYLOAD	25kg
REACH	1500mm

TITLE	LAYOUT		Q'TY	1
MODEL	H2515		W.T (kg)	73
SERIES	MAT.		SCALE	
H-SERIES	DRG. NO.	A3		
DATE	21.03.24			
			DOOSAN	