

ROS

Doosan Robot

M0609 | M0617 | M1013 | M1509
A0509 | A0509s | A0912 | A0912s
H2017 | H2515

ROS Programming Manual





- 1. Installation Doosan ROS package..... 11**
 - 1.1 Overview 11
 - 1.2 Prerequisite 11
 - 1.3 Installation..... 11

- 2. Operation mode 13**
 - 2.1 Virtual mode 13
 - 2.2 Real mode 13

- 3. dsr_description 16**
 - 3.1 dsr_description <robot_model>.launch..... 16

- 4. dsr_moveit 18**
 - 4.1 dsr_moveit_config 18
 - 4.2 dsr_control + moveit..... 20
 - 4.3 Moveit Commander..... 22

- 5. dsr_launcher 24**
 - 5.1 dsr_launcher 24

- 6. dsr_example 27**
 - 6.1 Single Robot..... 27
 - 6.2 Multi Robot..... 30
 - 6.3 Gripper..... 33
 - 6.4 Mobile robot..... 36

- 7. dsr_msgs 39**
 - 7.1 Topic 39
 - 7.1.1 RobotState.msg..... 39



7.1.2	RobotStop.msg	46
7.1.3	RobotError.msg	47
7.1.4	LogAlarm.msg	49
7.1.5	ModbusState.msg	51
7.1.6	JogMultiAxis.msg	52
7.2	Service/motion	53
7.2.1	Trans.srv	53
7.2.2	Fkin.srv	54
7.2.3	lkin.srv	55
7.2.4	SetRefCoord.srv	57
7.2.5	MoveJoint.srv	58
7.2.6	MoveLine.srv	60
7.2.7	MoveJointx.srv	63
7.2.8	MoveCircle.srv	65
7.2.9	MoveSplineJoint.srv	68
7.2.10	MoveSplineTask.srv	70
7.2.11	MoveBlending.srv	72
7.2.12	MoveSpiral.srv	74
7.2.13	MovePeriodic.srv	76
7.2.14	MoveWait.srv	79
7.2.15	MovePause.srv	80
7.2.16	MoveResume.srv	81
7.2.17	MoveStop.srv	82
7.2.18	Jog.srv	83
7.2.19	JogMulti.srv	84
7.2.20	CheckMotion.srv	85
7.2.21	ChangeOperationSpeed.srv	86
7.2.22	EnableAlterMotion.srv	87
7.2.23	AlterMotion.srv	89
7.2.24	DisableAlterMotion.srv	90
7.3	Service/system.....	91
7.3.1	GetRobotMode.srv	91
7.3.2	SetRobotMode.srv	92



7.3.3	GetRobotSystem.srv	93
7.3.4	SetRobotSystem.srv	94
7.3.5	GetRobotSpeedMode.srv	95
7.3.6	SetRobotSpeedMode.srv.....	96
7.3.7	SetSafeStopResetType.srv.....	97
7.3.8	GetCurrentPose.srv	98
7.3.9	GetLastAlarm.srv	99
7.4	Service/aux_control	101
7.4.1	GetControlMode.srv.....	101
7.4.2	GetControlSpace.srv	102
7.4.3	GetCurrentPosj.srv	103
7.4.4	GetCurrentVelj.srv	104
7.4.5	GetDesiredPosj.srv.....	105
7.4.6	GetDesiredVelj.srv.....	106
7.4.7	GetCurrentPosx.srv	107
7.4.8	GetCurrentToolFlangePosx.srv	108
7.4.9	GetCurrentVelx.srv	109
7.4.10	GetDesiredPosx.srv.....	110
7.4.11	GetDesiredVelx.srv	111
7.4.12	GetCurrentSolutionSpace.....	112
7.4.13	GetCurrentRotm.srv	113
7.4.14	GetJointTorque.srv	114
7.4.15	GetExternalTorque.srv.....	115
7.4.16	GetToolForce.srv.....	116
7.4.17	GetSolutionSpace.srv.....	117
7.4.18	GetOrientationError.srv	118
7.5	Service/tcp	119
7.5.1	ConfigCreateTcp.srv.....	119
7.5.2	ConfigDeleteTcp.srv	120
7.5.3	GetCurrentTcp.srv	121
7.5.4	SetCurrentTcp.srv	122
7.6	Service/tool.....	123



7.6.1	ConfigCreateTool.srv	123
7.6.2	ConfigDeleteTool.srv	124
7.6.3	GetCurrentTool.srv	125
7.6.4	SetCurrentTool.srv	126
7.6.5	SetToolShape.srv	127
7.7	Service/force.....	128
7.7.1	ParallelAxis1.srv	128
7.7.2	ParallelAxis2.srv	130
7.7.3	AlignAxis1.srv	131
7.7.4	AlignAxis2.srv	132
7.7.5	IsDoneBoltTightening.srv	133
7.7.6	ReleaseComplianceCtrl.srv	134
7.7.7	TaskComplianceCtrl.srv	135
7.7.8	SetStiffnessx.srv	136
7.7.9	CalcCoord.srv	137
7.7.10	SetUserCartCoord1.srv	139
7.7.11	SetUserCartCoord2.srv	140
7.7.12	SetUserCartCoord3.srv	141
7.7.13	OverwriteUserCartCoord.srv	142
7.7.14	GetUserCartCoord.srv	143
7.7.15	SetDesiredForce.srv	144
7.7.16	ReleaseForce.srv	145
7.7.17	CheckPositionCondition.srv	146
7.7.18	CheckForceCondition.srv	147
7.7.19	CheckOrientationCondition1.srv	148
7.7.20	CheckOrientationCondition2.srv	150
7.7.21	CoordTransform.srv	152
7.7.22	GetWorkpieceWeight.srv	154
7.7.23	ResetWorkppieceWeight.srv	155
7.8	Service/io.....	156
7.8.1	SetCtlBoxDigitalOutput.srv	156
7.8.2	GetCtlBoxDigitalOutput.srv	157
7.8.3	GetCtlBoxDigitalInput.srv	158



7.8.4	SetToolDigitalOutput.srv	159
7.8.5	GetToolDigitalOutput.srv	160
7.8.6	GetToolDigitalInput.srv	161
7.8.7	SetCtlBoxAnalogOutputType.srv	162
7.8.8	SetCtlBoxAnalogInputType.srv	163
7.8.9	SetCtlBoxAnalogOutput.srv	164
7.8.10	GetCtlBoxAnalogInput.srv	165
7.9	Service/modbus	166
7.9.1	ConfigCreateModbus.srv	166
7.9.2	ConfigDeleteModbus.srv	168
7.9.3	SetModbusOutput.srv	169
7.9.4	GetModbusInput.srv	170
7.10	Service/dri	171
7.10.1	DriStart.srv	171
7.10.2	DriStop.srv	172
7.10.3	DriPause.srv	173
7.10.4	DriResume.srv	174
7.10.5	GetDriState.srv	175
7.11	Service/gripper	176
7.11.1	SerialSendData.srv	176
7.11.2	RobotiqMove.srv	177
8.	Motion-related Functions	179
8.1	posj(q1=0, q2=0, q3=0, q4=0, q5=0, q6=0)	179
8.2	posx(x=0, y=0, z=0, w=0, p=0, r=0)	180
8.3	trans(pos, delta, ref, ref_out)	181
8.4	posb(seg_type, posx1, posx2=None, radius=0)	183
8.5	fkin(pos, ref)	185
8.6	ikin(pos, sol_space, ref)	187
8.7	set_velj(vel)	189
8.8	set_accj(acc)	190



8.9	set_velx(vel1, vel2).....	191
8.10	set_velx(vel).....	192
8.11	set_accx(acc1, acc2).....	193
8.12	set_accx(acc).....	195
8.13	set_tcp(name).....	196
8.14	set_ref_coord(coord).....	197
8.15	movej.....	198
8.16	movel.....	201
8.17	movejx.....	205
8.18	movec.....	208
8.19	movesj.....	212
8.20	movesx.....	215
8.21	moveb.....	219
8.22	move_spiral.....	223
8.23	move_periodic.....	226
8.24	amovej.....	231
8.25	amovel.....	234
8.26	amovejx.....	237
8.27	amovec.....	240
8.28	amovesj.....	243
8.29	amovesx.....	246
8.30	amoveb.....	249
8.31	amove_spiral.....	253
8.32	amove_periodic.....	256
8.33	mwait(time=0).....	259
8.34	check_motion().....	261
8.35	stop(st_mode).....	262
8.36	change_operation_speed(speed).....	264
8.37	enable_alter_motion(n, mode, ref, limit_dPOS, limit_dPOS_per).....	266



8.38	Alter_motion([x,y,z,rx,ry,rz])	269
8.39	disalbe_alter_motion().....	271
9.	Auxiliary Control Functions	273
9.1	get_control_mode().....	273
9.2	get_control_space()	274
9.3	get_current_posj()	275
9.4	get_current_velj().....	276
9.5	get_desired_posj().....	277
9.6	get_desired_velj()	278
9.7	get_current_posx(ref).....	279
9.8	get_current_tool_flange_posx()	280
9.9	get_current_velx().....	282
9.10	get_desired_posx(ref).....	283
9.11	get_desired_velx()	284
9.12	get_current_solution_space()	286
9.13	get_current_rotm(ref).....	287
9.14	get_joint_torque()	288
9.15	get_external_torque().....	289
9.16	get_tool_force(ref)	290
9.17	get_solution_space(pos)	291
10.	Other Settings and Safety-related Functions	292
10.1	get_workpiece_weight()	292
10.2	reset_workpiece_weight().....	293
10.3	set_tool(name)	294
10.4	set_tool_shape(name).....	295
10.5	set_singularity_handling(mode).....	296

11. Force/Stiffness Control and Other User-Friendly Features 298

11.1 parallel_axis(x1, x2, x3, axis, ref)	298
11.2 parallel_axis(vect, axis, ref).....	300
11.3 align_axis(x1, x2, x3, pos, axis, ref).....	302
11.4 align_axis(vect, pos, axis, ref).....	304
11.5 is_done_bolt_tightening(m=0, timeout=0, axis=None)	306
11.6 release_compliance_ctrl().....	308
11.7 task_compliance_ctrl(stx, time).....	309
11.8 set_stiffnessx(stx, time)	311
11.9 calc_coord(x1, x2, x3, x4, ref, mod).....	313
11.10set_user_cart_coord(pos, ref).....	316
11.11set_user_cart_coord(x1, x2, x3, pos, ref).....	318
11.12set_user_cart_coord(u1, v1, pos, ref).....	320
11.13overwrite_user_cart_coord(id, pos, ref).....	322
11.14get_user_cart_coord(id).....	324
11.15set_desired_force(fd, dir, time, mod).....	325
11.16release_force(time=0).....	327
11.17check_position_condition(axis, min, max, ref, mod, pos).....	328
11.18check_force_condition(axis, min, max, ref).....	330
11.19check_orientation_condition(axis, min, max, ref, mod).....	332
11.20check_orientation_condition(axis, min, max, ref, mod, pos).....	335
11.21coord_transform(pose_in, ref_in, ref_out).....	338

12. System Functions 340

12.1 Robot Mode	340
12.1.1 set_robot_mode(robot_mode)	340
12.1.2 get_robot_mode()	341
12.1.3 get_last_alarm()	342



12.1.4	set_safe_stop_reset_type(reset_type)	343
12.1.5	set_robot_speed_mode(speed_mode)	344
12.1.6	get_robot_speed_mode()	345
12.1.7	set_robot_system(robot_system)	346
12.1.8	get_robot_system()	347
12.1.9	get_robot_state()	348

122 IO 349

12.2.1	set_digital_output(index, val=None)	349
12.2.2	get_digital_output(index)	351
12.2.3	get_digital_input(index)	352
12.2.4	set_tool_digital_output(index, val=None)	353
12.2.5	get_tool_digital_output(index)	354
12.2.6	get_tool_digital_input(index)	355
12.2.7	set_mode_analog_output(ch, mod)	356
12.2.8	set_mode_analog_input(ch, mod)	357
12.2.9	set_analog_output(ch, val)	358
12.2.10	get_analog_input(ch)	359

13. External Communication Functions 360

13.1 Modbus..... 360

13.1.1	add_modbus_signal(ip, port, name, reg_type, index, value=0)	360
13.1.2	del_modbus_signal(name)	364
13.1.3	set_modbus_output(iobus, val)	365
13.1.4	get_modbus_input(iobus)	366

1. Installation Doosan ROS package

1.1 Overview

- **Doosan robotics ROS package**

Doosan robotics ROS package is a metapackage for running Doosan cooperative robots on ROS URDF model is provided, simulation is possible through Rviz, Gazebo, and the real robot can be driven through movelt or various examples.

1.2 Prerequisite

- **System**

You must use an x86 system.

We recommend a workstation-class PC for the best simulation.

- **OS & Distro**

Ubuntu 16.04(32/64bit) + ROS kinetic or melodic

1.3 Installation

- **Install the source from github**

Download and build the source from Doosan robotics

Github : <https://github.com/doosan-robotics/doosan-robot>

- **How to Install**

```
### We recommend the /home/ <user>/catkin_ws/src
$ mkdir -p /home/ <user>/catkin_ws/src
$ cd /home/ <user>/catkin_ws/src
$ catkin_init_workspace
$ git clone https://github.com/doosan-robotics/doosan-robot
$ rosdep install --from-paths doosan-robot --ignore-src --rosdistro kinetic -r -y
$ catkin_make
$ source ./devel/setup.bash
```



Chapter1 Installation Doosan ROS package

In this manual, workspace was used as '~/catkin_ws'

2. Operation mode

2.1 Virtual mode

▪ Feature

- If you are driving without a real robot, use virtual mode.
- Selecting virtual mode sets the mode argument to virtual when running the dsr_launcher launch file. If you omit the argument, it defaults to virtual. .

```
ex> roslaunch dsr_launcher single_robot_gazebo.launch mode:=virtual
```

- When ROS launches in virtual mode, the emulator(DRCF) runs automatically.
 - (DRCF) location: doosan-robot/common/bin/ DRCF
- One emulator is required for each robot.
- When controlling multiple robots, the emulator will automatically run as many as the number of robots and use different port.

2.2 Real mode

▪ Feature

- Use real mode to drive a real robot.
- In real mode operation, communication must be established with the real robot controller.
- The default IP of the robot controller is 192.168.127.100 and the port is 12345.
- Selecting arguments(**mode:=real host:=192.168.127.100 port:=12345**) to real mode when running the dsr_launcher launch file.

```
ex> roslaunch dsr_launcher single_robot_gazebo.launch mode:=real  
host:=192.168.127.100 port:=12345
```

▪ Connect with Controller

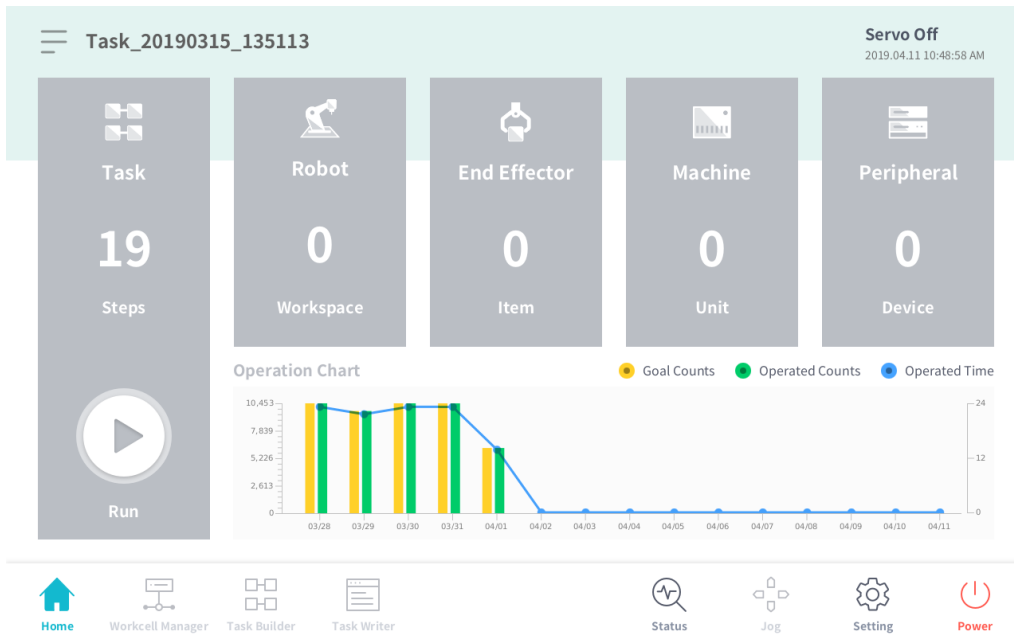

Figure 2.2 Teach Pandaunt Screen

- The user can set static IP in Setting -> Network of TP screen.

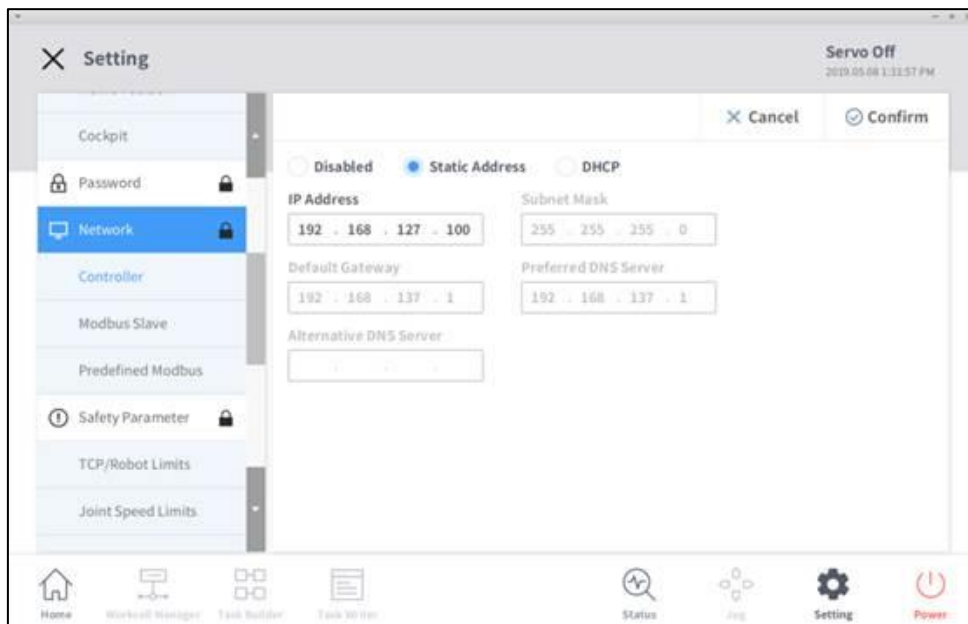

Figure 2.3 Check robot controller IP on TP

- Check the IP of the controller set in the Network tab, and set this IP in the ROS (host := ROBOT_IP)
- If the ROS control node is correctly executed, ROS has the robot control.
- If the TP transfer control, below pop-up message on the TP screen.

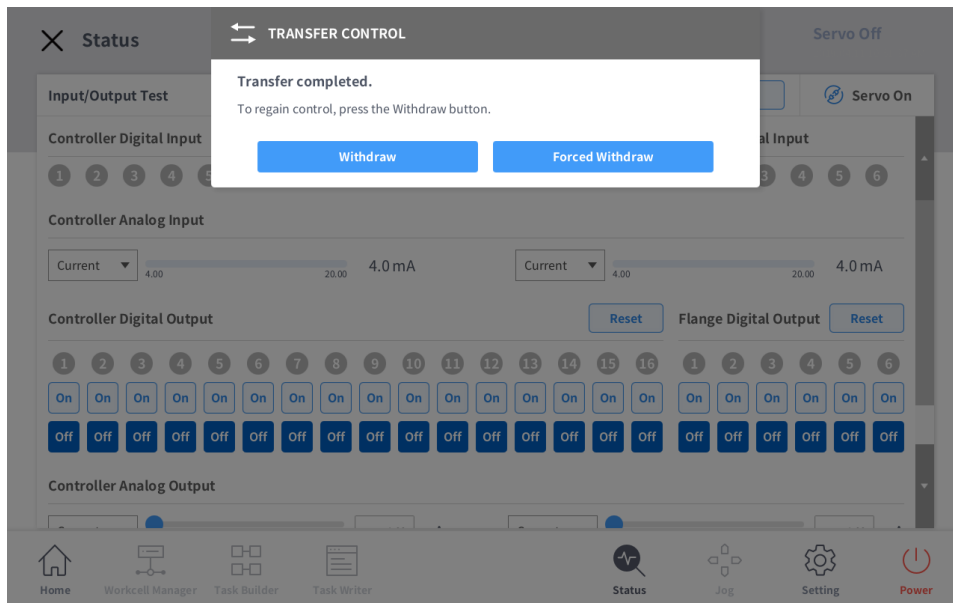

Figure 2.4 Transfer Control pop-up message

3. dsr_description

3.1 dsr_description <robot_model>.launch

▪ Feature

- Launch the robot model on Rviz simulator and load Joint_state_publisher.
- The robot can be moved by using Joint_state_publisher.

▪ Parameter

Parameter Name	Data Type	Default Value	Description
model	-	m1013	M-Series Robot model . m0609, m0617, m1013, m1509 A-Series Robot model . a0509
color	-	white	Robot Color . white or blue
gripper	-	none	using gripper or not . none : not use gripper . robotiq_2f : use robotiq 2finger gripper

▪ Example

```

$ roslaunch dsr_description m0609.launch
$ roslaunch dsr_description m1013.launch color:=blue # Change Color
$ roslaunch dsr_description m1509.launch gripper:=robotiq_2f # insert robotiq
gripper
$ roslaunch dsr_description m0617.launch color:=blue gripper:=robotiq_2f
$ roslaunch dsr_description a0509.launch # A-Series
    
```

Robot and Joint_state_publisher are loaded on Rviz simulator (Figure 3.1).
The robot can be moved by using Joint_state_publisher.

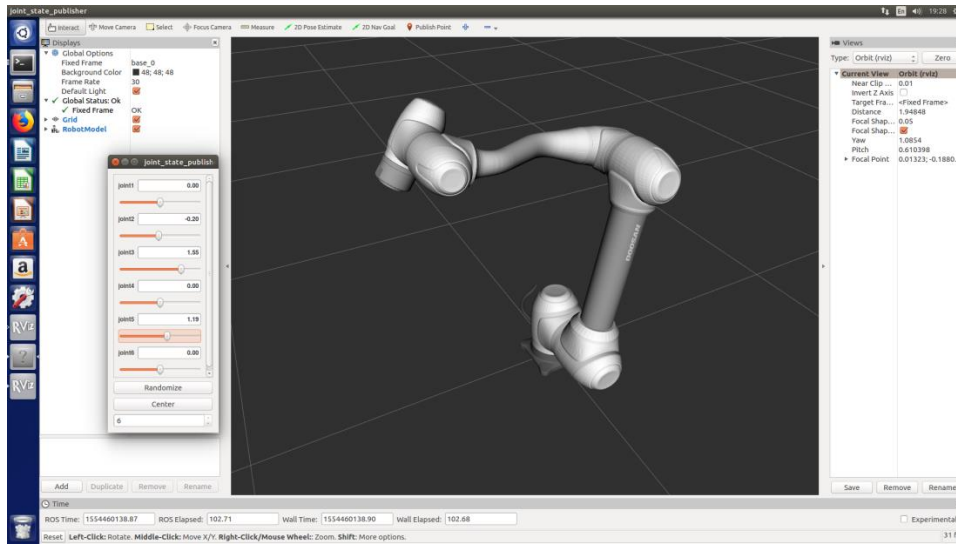

Figure 3.1 Robot on the Rviz simulator

4. dsr_moveit

4.1 dsr_moveit_config

▪ Feature

- Launch the robot model on Rviz simulator and operated by Moveit.
- It only works in simulation mode.

▪ Parameter

Parameter Name	Data Type	Default Value	Description
color	-	white	Robot Color . white or blue

▪ Example

```
$ roslaunch moveit_config_m0609 m0609.launch  
$ roslaunch moveit_config_m0617 m0617.launch  
$ roslaunch moveit_config_m1013 m1013.launch color:=blue  
$ roslaunch moveit_config_m1509 m1509.launch  
$ roslaunch moveit_config_a0509 a0509.launch
```

Robot and Motion Planning Interface window are loaded on Rviz(Figure 4.1)
MotionPlanning allows the robot to run virtually.

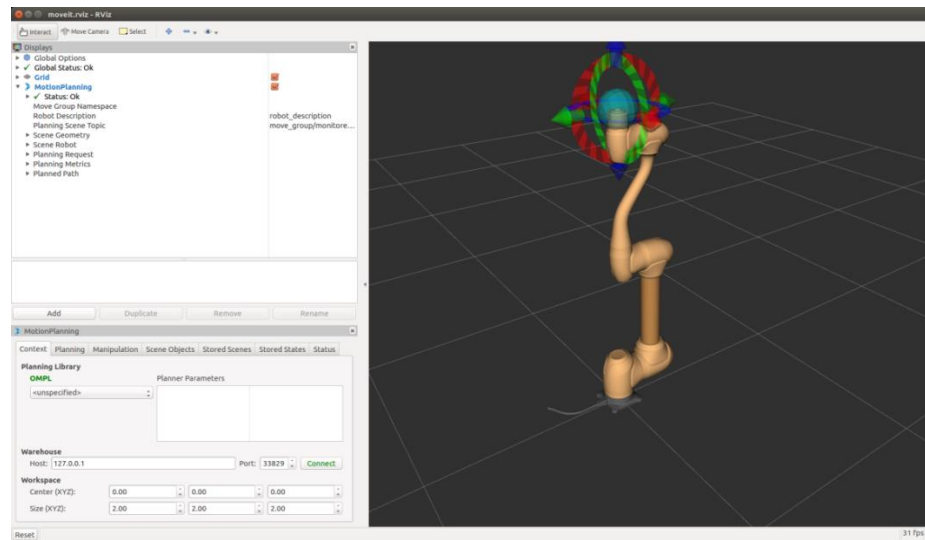

Figure 4.1 Rviz + MoveIt

4.2 dsr_control + moveit

▪ Feature

- Launch the robot model on Rviz simulator and operated by Moveit.
- Working by connecting with emulator mode or real robot.
- The emulator mode only works in virtual mode.

▪ Parameter

Paramater Name	Data Type	Default Value	Description
host	-	127.0.0.1	Robot Controller IP . Emulator : 127.0.0.1 . Real robot controller : 192.168.127.100
port	-	12345	port
mode	-	virtual	Robot operation mode - virtual : virtual mode - real : real mode
model	-	m1013	M-Series Robot model . m0609, m0617, m1013, m1509 A-Series Robot model . a0509
color	-	white	Robot color . white or blue
gripper	-	none	using gripper or not . none : not use gripper . robotiq_2f : use robotiq 2finger gripper

▪ Example

<virtual mode>

```
$ roslaunch dsr_control dsr_moveit.launch model:=m0609 mode:=virtual
```

```
$ roslaunch dsr_control dsr_moveit.launch model:=m0617
$ roslaunch dsr_control dsr_moveit.launch model:=m1013 mode:=virtual color:=blue
```

<real mode>

Robot controller IP default = 192.168.127.100, port = 12345

```
$ roslaunch dsr_control dsr_moveit.launch model:=m1509 host:=192.168.127.100
mode:=real color:=blue gripper:=robotiq_2f
```

```
$ roslaunch dsr_control dsr_moveit.launch model:=a0509 host:=192.168.127.100
mode:=real
```

The Robot and Motion Planning Interface window are loaded on Rviz(Figure 4.2).
The MotionPlanning allows the robot to run in real environment.

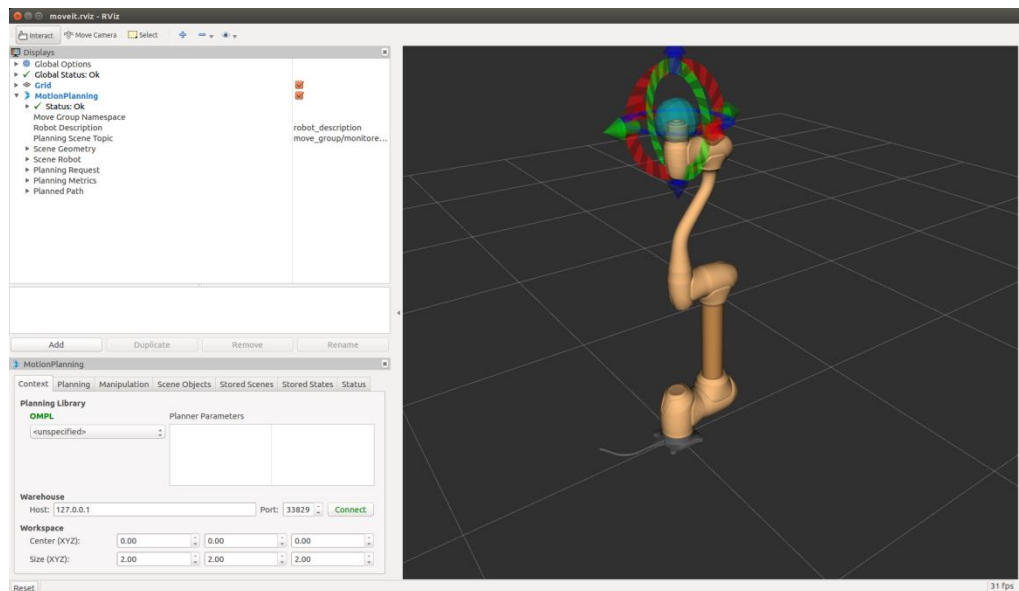

Figure 4.2 Rviz + dsr_control

4.3 Moveit Commander

▪ Feature

- Control the robot through Moveit Commander..

▪ Install

- `sudo apt-get install ros-kinetic-moveit-commander`

▪ Example

<virtual mode>

```
$ roslaunch dsr_control dsr_moveit.launch model:=m1013 mode:=virtual
```

```
$ ROS_NAMESPACE=/dsr01m1013 rosrunc moveit_commander  
moveit_commander_cmdline.py robot_description:=/dsr01m1013/robot_description
```

```
> use arm  
> goal0 = [0 0 0 0 0 0] # save the home position to variable "goal0"  
> goal1 = [0 0 1.57 0 1.57 0] # save the target position to variable "goal1" / radian  
> go goal1 # plan & execute (the robot is going to move target position)  
> go goal0 # plan & execute (the robot is going to move home position)
```

<real mode>

Robot controller IP default = 192.168.127.100, port = 12345

```
$ roslaunch dsr_control dsr_moveit.launch model:=a0509 host:=192.168.127.100  
mode:=real
```

```
$ ROS_NAMESPACE=/dsr01a0509 rosrunc moveit_commander  
moveit_commander_cmdline.py robot_description:=/dsr01a0509/robot_description
```

```
> use arm  
> goal0 = [0 0 0 0 0 0] # save the home position to variable "goal0"
```



```
> goal1 = [0 0 1.57 0 1.57 0] # save the target position to variable "goal1" / radian
```



5. dsr_launcher

5.1 dsr_launcher

▪ Feature

- Configure various robot environment through dsr_launcher.
- The user can build Single Robot, Multi Robot, Gripper, mobile environment according to Paramater.
- Multi Robot configuration is an extension of Single Robot configuration. This is an example of 2 robots of Multi Robot configuration basically provided in this package. Please modify the dsr_launcher / multi-robot *.launch files to the appropriate configuration for your environment. (ns, host, port, model, etc. should be corrected correctly.)
- After loading dsr_launcher, run dsr_example for each environment with rosrn.
(For details, see Chapter 6, dsr_example.)

▪ Paramater

Parameter Name	Datatype	Default Value	Description
ns	-	dsr01	ROBOT name space . single robot : dsr01 . multi robot: dsr01, dsr02, dsr03, dsr04 ...
host	-	127.0.0.1	Robot controller IP . Emulator : 127.0.0.1 . Real robot controller : 192.168.127.100
port	-	12345	port
mode	-	virtual	Robot operation mode - virtual : virtual mode - real : real mode
model	-	m1013	M-Series Robot model . m0609, m0617, m1013, m1509 A-Series Robot model

Parameter Name	Datatype	Default Value	Description
			. a0509
color	-	white	Robot color . white or blue
gripper	-	none	using gripper or not . none : not use gripper . robotiq_2f : use robotiq 2finger gripper
mobile	-	none	using mobile robot or not . none : not use mobile robot . husky : use husky mobile robot

▪ Examples

<single robot>

- rviz, virtual mode, m1013(white)

```
$ roslaunch dsr_launcher single_robot_rviz.launch mode:=virtual model:=m1013
```

- gazebo, real mode, m1013(blue)

```
$ roslaunch dsr_launcher single_robot_gazebo.launch host:=192.168.127.100 port:=12345 mode:=real color:=bule
```

- rviz+gazebo, real mode, m1013(white)

```
$ roslaunch dsr_launcher single_robot_rviz_gazebo.launch host:=192.168.127.100 port:= 12345 mode:=real
```

- + gripper

```
$ roslaunch dsr_launcher single_robot_rviz_gazebo.launch gripper:=robotiq_2f
```

- + mobile

```
$ roslaunch dsr_launcher single_robot_rviz_gazebo.launch gripper:=robotiq_2f mobile:=husky
```

<multi robot>

- rviz, virtual mode, m1013 x 2

```
$ roslaunch dsr_launcher multi_robot_rviz.launch
```

- gazebo, virtual mode, m1013 x 2



```
$ roslaunch dsr_launcher multi_robot_gazebo.launch  
- rviz + gazebo, virtual mode, m1013 x 2  
$ roslaunch dsr_launcher multi_robot_rviz_gazebo.launch
```

6. dsr_example

▪ Feature

- Provides an example of robot operation according to robot environment configured through dsr_launcher.

(Please refer to Chapter 5, "dsr_launcher" for detailed robot environment configuration.)

- The example files was written by python.
 - Directory of .py files: ~/catkin_ws/src/doosan-robot/dsr_example/py/scripts

6.1 Single Robot

▪ Feature

- Provides an example of operating a Single Robot.

(Please refer to Chapter 5, "dsr_launcher" for detailed robot environment configuration.)

- The example files was written in python
 - Directory of .py files: ~/catkin_ws/src/doosan-robot/dsr_example/py/scripts/simple

▪ Paramaters of dsr_launcher

Parameter Name	Datatype	Default Value	Description
ns	-	dsr01	ROBOT name space . single robot : dsr01 . multi robot: dsr01, dsr02, dsr03, dsr04 ...
host	-	127.0.0.1	Robot controller IP . Emulator : 127.0.0.1 . Real robot controller : 192.168.127.100
port	-	12345	port
mode	-	virtual	Robot operation mode

Parameter Name	Datatype	Default Value	Description
			- virtual : virtual mode - real : real mode
model	-	m1013	M-Series Robot model . m0609, m0617, m1013, m1509 A-Series Robot model . a0509
color	-	white	Robot color . white or blue
gripper	-	none	using gripper or not . none : not use gripper . robotiq_2f : use robotiq 2finger gripper
mobile	-	none	using mobile robot or not . none : not use mobile robot . husky : use husky mobile robot

▪ Example

1. Robot controller default IP/Port

- IP : 192.168.127.100 , port = 12345

2. launch

Run dsr_launcher for your desired configuration.

- single robot in rviz, virtual mode, m1013(white)

```
$ roslaunch dsr_launcher single_robot_rviz.launch mode:=virtual model:=m1013
color:=white
```

- single robot in gazebo, real mode, m1013(blue)

```
$ roslaunch dsr_launcher single_robot_gazebo.launch mode:=real
host:=192.168.127.100 model:=m1013 color:=blue
```

- single robot in rviz + gazebo, virtual mode, m1013(white)

```
$ roslaunch dsr_launcher single_robot_rviz_gazebo.launch model:=m1013
color:=white
```

3. run application node

- Edit example files

. Open the example file you want to run and modify the `ROBOT_ID` and `ROBOT_MODEL` accordingly.

.. ex>

```
ROBOT_ID = "dsr01"
```

```
ROBOT_MODEL = "m1013"
```

```
$ rosrn dsr_example_py single_robot_simple.py
```

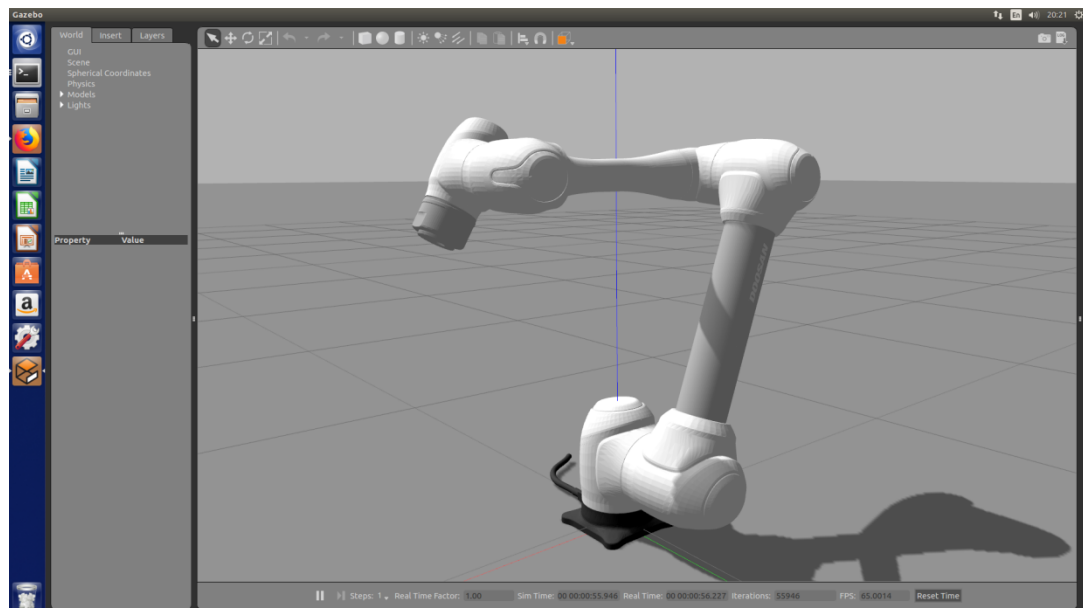

Figure 6.2 single robot

6.2 Multi Robot

▪ Feature

- Provides an example of driving Multi Robot.
(Please refer to Chapter 5, "dsr_launcher" for detailed robot environment configuration.)
- The example files was written in python
 - Directory of .py files: ~/catkin_ws/src/doosan-robot/dsr_example/py/scripts/simple

▪ Paramaters of dsr_launcher

Parameter Name	Datatype	Default Value	Description
ns	-	dsr01	ROBOT name space . single robot : dsr01 . multi robot: dsr01, dsr02, dsr03, dsr04 ...
host	-	127.0.0.1	Robot controller IP . Emulator : 127.0.0.1 . Real robot controller : 192.168.127.100
port	-	12345	port
mode	-	virtual	Robot operation mode - virtual : virtual mode - real : real mode
model	-	m1013	M-Series Robot model . m0609, m0617, m1013, m1509 A-Series Robot model . a0509
color	-	white	Robot color . white or blue
gripper	-	none	using gripper or not . none : not use gripper . robotiq_2f : use robotiq 2finger gripper

Parameter Name	Datatype	Default Value	Description
mobile	-	none	using mobile robot or not . none : not use mobile robot . husky : use husky mobile robot

▪ Example

1. Robot controller default IP/Port

- IP : 192.168.127.100 , port = 12345
- For multi robot, set the IP of each robot controller differently

1. launch

- edit launch file
 - . \$ cd ~/catkin_ws/src/doosan-robot/dsr_launcher/launch
 - . Modify the multi_robot_*.launch file for each situation.
 - .. edit argument ns host port, model...
- multi robot in rviz

```
$ roslaunch dsr_launcher multi_robot_rviz.launch model:=m1013
```

- multi robot in gazebo

```
$ roslaunch dsr_launcher multi_robot_gazebo.launch color:=bule
```

- multi robot in rviz + gazebo

```
$ roslaunch dsr_launcher multi_robot_rviz_gazebo.launch
```

2. run application node

- Edit example files
 - . Open the example file you want to run and modify the robot_id and robot_model accordingly.

```
.. ex>
```

```
robot_id1 = "dsr01"; robot_model1 = "m1013"
```

```
robot_id2 = "dsr02"; robot_model2 = "m1013"
```

```
$ rosrn dsr_example_py multi_robot_simple.py
```

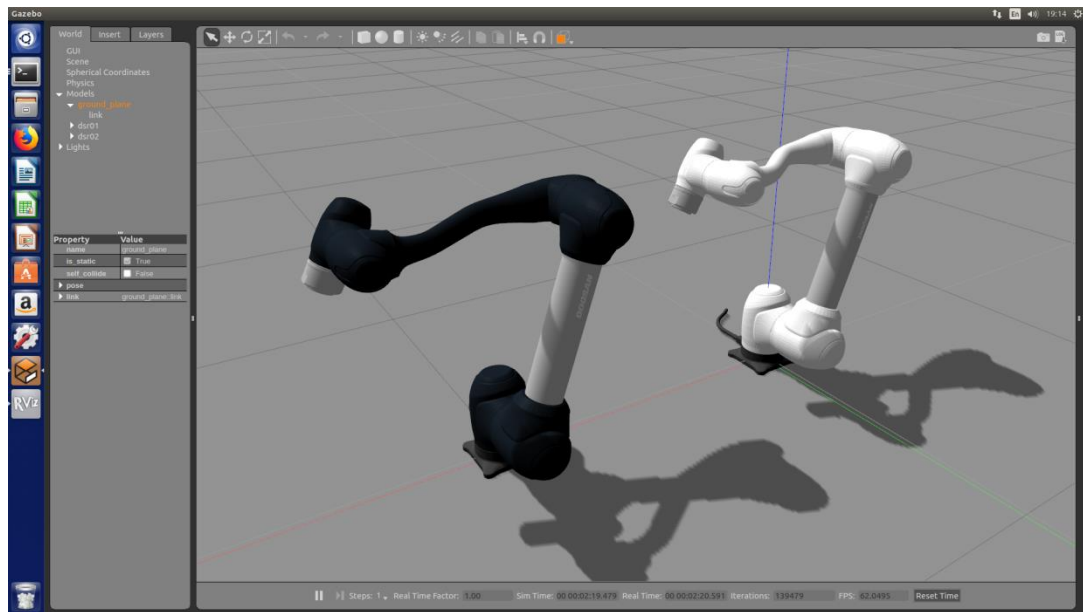

Figure 6.3 multi robot

6.3 Gripper

▪ Feature

- Provides an example of using gripper (robotiq_2f)
(Please refer to Chapter 5, "dsr_launcher" for detailed robot environment configuration.)
- When running dsr_launcher, give argument (**gripper: = robotiq_2f**).
- The example files was written in python
- Directory of .py files: ~/catkin_ws/src/doosan-robot/dsr_example/py/scripts/gripper

▪ Praramaters of dsr_launcher

Parameter Name	Datatype	Default Value	Description
ns	-	dsr01	ROBOT name space . single robot : dsr01 . multi robot: dsr01, dsr02, dsr03, dsr04 ...
host	-	127.0.0.1	Robot controller IP . Emulator : 127.0.0.1 . Real robot controller : 192.168.127.100
port	-	12345	port
mode	-	virtual	Robot operation mode - virtual : virtual mode - real : real mode
model	-	m1013	M-Series Robot model . m0609, m0617, m1013, m1509 A-Series Robot model . a0509
color	-	white	Robot color . white or blue
gripper	-	none	using gripper or not . none : not use gripper

Parameter Name	Datatype	Default Value	Description
			. robotiq_2f : use robotiq 2finger gripper
mobile	-	none	using mobile robot or not . none : not use mobile robot . husky : use husky mobile robot

▪ Example

1. Robot controller default IP/Port

- IP : 192.168.127.100 , port = 12345

2. launch : single robot + gripper

- single robot in rviz

```
$ roslaunch dsr_launcher single_robot_rviz.launch model:=m1013
```

```
gripper:=robotiq_2f
```

- single robot in gazebo

```
$ roslaunch dsr_launcher single_robot_gazebo.launch model:=m1013
```

```
gripper:=robotiq_2f
```

- single robot in rviz + gazebo

```
$ roslaunch dsr_launcher single_robot_rviz_gazebo.launch model:=m1013
```

```
gripper:=robotiq_2f
```

3. run application node

- Edit example files

. Open the example file you want to run and modify the **ROBOT_ID** and **ROBOT_MODEL** accordingly.

```
.. ex>
```

```
ROBOT_ID = "dsr01"
```

```
ROBOT_MODEL = "m1013"
```

```
$ rosrn dsr_example_py pick_and_place.py
```

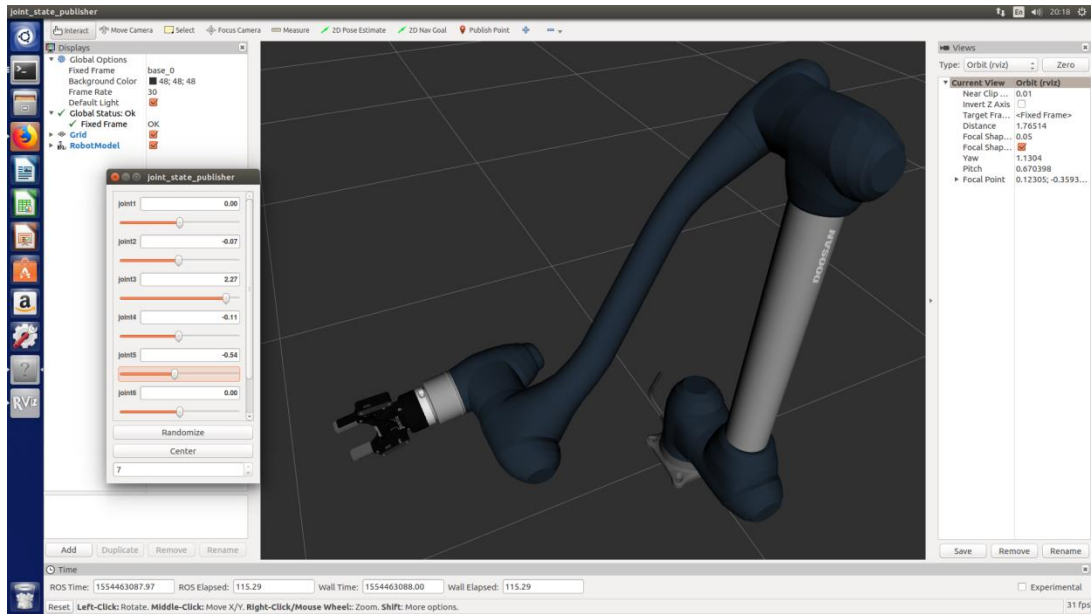

Figure 6.4 robot + gripper

6.4 Mobile robot

▪ Feature

- Provides mobile robot(huskey) examples.
(Please refer to Chapter 5, "dsr_launcher" for detailed robot environment configuration.)
- When running dsr_launcher, give argument (**mobile:=husky**).
- The example files was written in python
 - Directory of .py files: ~/catkin_ws/src/doosan-robot/dsr_example/py/scripts/mobile

▪ Paramaters of dsr_launcher

Parameter Name	Datatype	Default Value	Description
ns	-	dsr01	ROBOT name space . single robot : dsr01 . multi robot: dsr01, dsr02, dsr03, dsr04 ...
host	-	127.0.0.1	Robot controller IP . Emulator : 127.0.0.1 . Real robot controller : 192.168.127.100
port	-	12345	port
mode	-	virtual	Robot operation mode - virtual : virtual mode - real : real mode
model	-	m1013	M-Series Robot model . m0609, m0617, m1013, m1509 A-Series Robot model . a0509
color	-	white	Robot color . white or blue
gripper	-	none	using gripper or not . none : not use gripper

Parameter Name	Datatype	Default Value	Description
			. robotiq_2f : use robotiq 2finger gripper
mobile	-	none	using mobile robot or not . none : not use mobile robot . husky : use husky mobile robot

▪ Example

1. Robot controller default IP/Port

- IP : 192.168.127.100 , port = 12345

2. launch : single robot + mobile

- single robot in rviz

```
$ roslaunch dsr_launcher single_robot_rviz.launch model:=m1013 mobile:=husky
```

- single robot in gazebo

```
$ roslaunch dsr_launcher single_robot_gazebo.launch model:=m1013 mobile:=husky
```

- single robot in rviz + gazebo

```
$ roslaunch dsr_launcher single_robot_rviz_gazebo.launch model:=m1013
```

```
mobile:=husky
```

3. run application node

- Edit example files

. Open the example file you want to run and modify the ROBOT_ID and ROBOT_MODEL accordingly.

```
.. ex>
```

```
ROBOT_ID = "dsr01"
```

```
ROBOT_MODEL = "m1013"
```

```
$ rosrn dsr_example_py single_robot_moblie.py
```

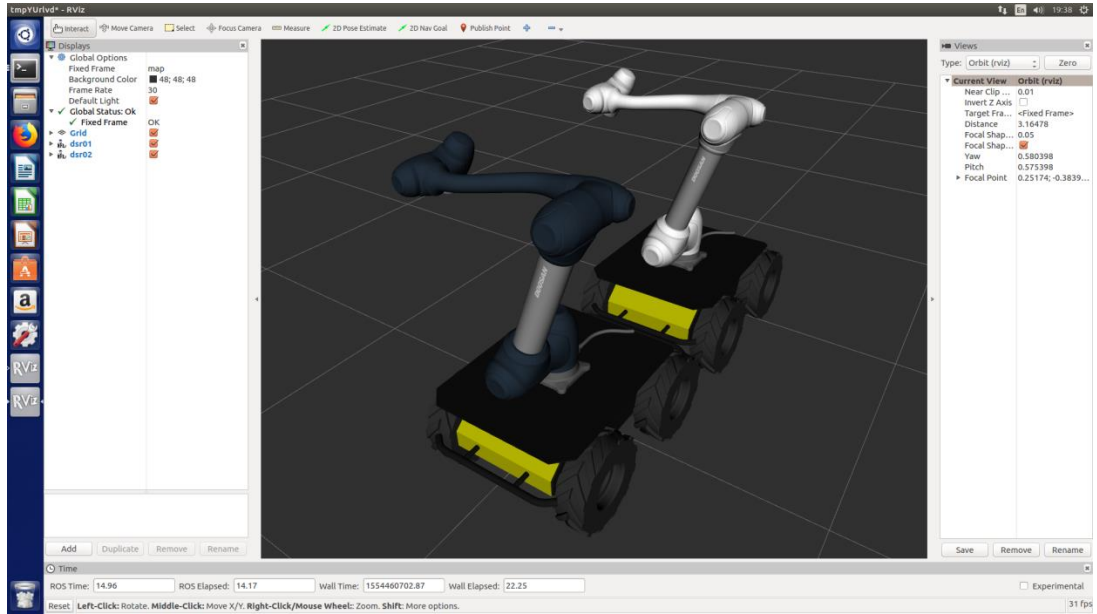

Figure 6.5 robot on mobile

7. dsr_msgs

7.1 Topic

7.1.1 RobotState.msg

- **Features**

Topic message of robot state.

- **Parameters**

Parameter Name	Data Type	Default Value	Description
robot_state	int32		Robot State : enum.ROBOT_STATE
robot_state_str	string		Output robot status as string
actual_mode	int8		Robot Control Mode: enum.CONTROL_MODE
actual_space	int8		Robot Control Space: enum.ROBOT_SPACE
current_posj	float64[6]		6 current joint angle
joint_abs	float64[6]		6 current joint angle(Absolute Encorder)
current_velj	float64[6]		6 current joint velocity
joint_err	float64[6]		6 current joint error
target_posj	float64[6]		6 target joint angle
target_velj	float64[6]		6 target joint velocity
current_posx	float64[6]		6 current task position
current_tool_posx	float64[6]		6 current flange position
current_velx	float64[6]		6 current task velocity
task_err	float64[6]		6 current task error
target_posx	float64[6]		6 target task position
target_velx	float64[6]		6 target task velocity



Parameter Name	Data Type	Default Value	Description
solution_space	int8		solution space(0~7)
rotation_matrix	std_msgs/Float64MultiArray[]		Rotation matrix: float[3][3]
dynamic_tor	float64[6]		6 dynamic torque
actual_jts	float64[6]		6 joint torque sensor data
actual_ejt	float64[6]		6 current joint axis external force
actual_ett	float64[6]		6 current Task-based external forces
actual_w2b	float64[6]		Position deviation between 6 World and Base coordinate systems This argument is only available in M2.50 and higher versions.
current_posw	std_msgs/Float64MultiArray[]		6 current task position based on world coordinate system This argument is only available in M2.50 and higher versions.
current_velw	float64[6]		6 current task velocity based on world coordinate system This argument is only available in M2.50 and higher versions.
world_ett	float64[6]		6 external force based on world coordinate system This argument is only available in M2.50 and higher versions.
target_posw	float64[6]		6 target task position based on world coordinate system This argument is only available in M2.50 and higher versions.
target_velw	float64[6]		6 target task velocity based on world coordinate system This argument is only available in M2.50 and higher versions.

Parameter Name	Data Type	Default Value	Description
rotation_matrix_world	std_msgs/Float64MultiArray[]		Rotation matrix based on world coordinate system: float[3][3] This argument is only available in M2.50 and higher versions.
actual_UCN	int8		User coordinate ID information(101 ~ 200) This argument is only available in M2.50 and higher versions.
parent	int8		Parent coordinate of current user coordinate system This argument is only available in M2.50 and higher versions.
current_posu	float64[6]		6 current task position based on user coordinate system This argument is only available in M2.50 and higher versions.
current_velu	float64[6]		6 current task velocity based on user coordinate system This argument is only available in M2.50 and higher versions.
user_ett	float64[6]		6 external force based on user coordinate system This argument is only available in M2.50 and higher versions.
target_posu	float64[6]		6 target task position based on user coordinate system This argument is only available in M2.50 and higher versions.
target_velu	float64[6]		6 target task velocity based on user coordinate system This argument is only available in M2.50 and higher versions.
rotation_matrix_user	std_msgs/Float64MultiArray[]		Rotation matrix based on user coordinate system: float[3][3] This argument is only available in M2.50 and higher versions.



Parameter Name	Data Type	Default Value	Description
sync_time	int8		Internal clock count
flange_digital_output	int8[6]		6 flange digital output
flange_digital_input	int8[6]		6 Flange Digital Input
actual_bk	int8[6]		6 break state
actual_bt	int8[5]		5 robot button information
actual_mc	float64[6]		Current consumption of 6 motors
actual_mt	float64[6]		6 inverter temperature information
ctrlbox_digital_input	int8[6]		16 control boxes digital input information
actual_ai	int8[2]		2 Analog Input numeric information
actual_sw	int8[3]		3 switch state
actual_si	int8[2]		2 safety input state
actual_at	int8[2]		2 analog input type information This argument is only available in M2.50 and higher versions.
ctrlbox_digital_output	int8[16]		16 control box digital output information
target_ao	float64[2]		2 Analog Output numeric information
target_at	int8[2]		2 analog output type information This argument is only available in M2.50 and higher versions.
actual_es	int8[2]		2 Encoder state information This argument is only available in M2.50 and higher versions.
actual_ed	int8[2]		2 Encoder Raw data numerical information
actual_er	int8[2]		2 Encoder Reset status information This argument is only available in M2.50 and higher versions.

Parameter Name	Data Type	Default Value	Description
modbus_state	ModbusState[]		Modbus State : ModbusState.msg 참조
access_control	int32		Control state: enum.ACCESS_CONTROL 참조

enum.ROBOT_STATE

Num	name	Description
0	STATE_INITIALIZING	It is an initialization state for setting various parameters by automatically entering by TP application.
1	STATE_STANDBY	Operable Standby state.
2	STATE_MOVING	It is a command operation state that is automatically switched when the command is received after receiving the command in the command wait state. When the operation is completed, it is switched to the auto command waiting state.
3	STATE_SAFE_OFF	Robot stop mode due to function and operation error, Servo off state (motor and brake power are cut off after control stop)
4	STATE_TEACHING	Direct teaching state
5	STATE_SAFE_STOP	Robot stop mode due to function and operation error. Safe stop status (status in which only the control is stopped, program suspended status in the automatic mode)
6	STATE_EMERGENCY_STOP:	Emergency stop state
7	STATE_HOMMING	Homing mode state (state in which robot is aligned in hardware).
8	STATE_RECOVERY	When the robot is stopped due to an error such as exceeding the robot driving range, it is in the recovery mode state to move within the driving range.

Num	name	Description
9	eSTATE_SAFE_STOP2	Same as eSTATE_SAFE_STOP but a state that must be switched to recovery mode because the robot is out of range
10	STATE_SAFE_OFF2	Same as eSTATE_SAFE_OFF state, but must be in recovery mode due to exceeding the robot drive range
11	STATE_RESERVED1	reserved
12	STATE_RESERVED2	reserved

enum.CONTROL_MODE

Num	name	Description
0	CONTROL_MODE_POSITION	Position control mode
1	CONTROL_MODE_TORQUE	Torque control mode

enum.ROBOT_STATE

Num	name	Description
0	ROBOT_SPACE_JOINT	Joint space
1	ROBOT_SPACE_TASK	Task Space

enum.ACCESS_CONTROL

Num	name	Description
0	MANAGE_ACCESS_CONTROL_FORCE_REQUEST	Control forced release message transmission
1	MANAGE_ACCESS_CONTROL_REQUEST,	Send control request message
2	MANAGE_ACCESS_CONTROL_RESPONSE_YES	Send control authorization request acknowledge message



Num	name	Description
3	MANAGE_ACCESS_CONTROL_RESPONSE_NO	Send control permission request decline message

7.1.2 RobotStop.msg

▪ Features

Topic message of robot stop.

▪ Parameters

Parameter Name	Data Type	Default Value	Description
stop_mode	int32		robot stop mode : Refer to enum.STOP_MODE.

enum.STOP_MODE

Num	name	Description
0	STOP_TYPE_QUICK_STO,	reserved
1	STOP_TYPE_QUICK	quick stop (motion trajectory maintenance)
2	STOP_TYPE_SLOW	slow stop (motion trajectory maintenance)
3	STOP_TYPE_HOLD	Emergency stop
	STOP_TYPE_EMERGENCY	Emergency stop

7.1.3 RobotError.msg

▪ Features

Topic message of robot error.

▪ Parameters

Parameter Name	Data Type	Default Value	Description
Level	int32	-	Log level : enum.LOG_LEVEL
Group	int32	-	Log group : enum.LOG_GROUP
Code	int32	-	error code
msg1	string	-	error msg 1
msg2	string	-	error msg 2
msg3	string	-	error msg 3

enum.LOG_LEVEL

Num	name	Description
0	LOG_LEVEL_RESERVED	reserved
1	LOG_LEVEL_SYSINFO	Informational messages about simple functions and operational errors
2	LOG_LEVEL_SYSWARN	Robot is stopped due to simple function and operation error.
3	LOG_LEVEL_SYSERROR	Robot is stopped due to safety issue or device error.

enum.LOG_GROUP

Num	name	Description
0	LOG_GROUP_RESERVED	reserved
1	LOG_GROUP_SYSTEMFMK	Robot Controller (framework)



Num	name	Description
2	eLOG_GROUP_MOTIONLIB,	Robot Controller (motion)
3	LOG_GROUP_SMARTTP	TP application (GUI)
4	LOG_GROUP_INVERTER	Inverter board
5	LOG_GROUP_SAFETYCONTROLLER	Safety board (Safety Controller)

7.1.4 LogAlarm.msg

▪ Features

Topic message of log alarm

▪ Parameters

Parameter Name	Data Type	Default Value	Description
level	int32	-	Log level : enum.LOG_LEVEL
group	int32	-	Log group : enum.LOG_GROUP
index	int32	-	error code
param	string	-	messages[3]

enum.LOG_LEVEL

Num	name	Description
0	LOG_LEVEL_RESERVED	reserved
1	LOG_LEVEL_SYSINFO	Informational messages about simple functions and operational errors
2	LOG_LEVEL_SYSWARN	Robot is stopped due to simple function and operation error.
3	LOG_LEVEL_SYSERROR	Robot is stopped due to safety issue or device error.

enum.LOG_GROUP

Num	name	Description
0	LOG_GROUP_RESERVED	reserved
1	LOG_GROUP_SYSTEMFMK	Robot Controller (framework)
2	eLOG_GROUP_MOTIONLIB,	Robot Controller (motion)
3	LOG_GROUP_SMARTTP	TP application (GUI)



Num	name	Description
4	LOG_GROUP_INVERTER	Inverter board
5	LOG_GROUP_SAFETYCONTROLLER	Safety board (Safety Controller)

7.1.5 ModbusState.msg

- **Features**

Topic message of Modbus State

- **Parameters**

Parameter Name	Data Type	Default Value	Description
level	string	-	Modbus Signal Name.
group	int32	-	Modbus Register Value (Unsigned : 0 ~ 65535)

7.1.6 JogMultiAxis.msg

Features

Topic message for multi-axis jog control

Multi-axis jog speed = $(250\text{mm/s})/\sqrt{3} \times [\text{Unit vector}] \times \text{speed}[\%]$



Caution

This message is available with robot controller software version 2.50 or later.

Parameters

Parameter Name	Data Type	Default Value	Description
jog_axis	float64[6]	-	Unit vector orientation of task space [Tx, Ty, Tz, Rx, Ry, Rz] (-1.0 ~ 1.0)
move_reference	int8	-	0: MOVE_REFERENCE_BASE 1: MOVE_REFERENCE_TOOL: 2: MOVE_REFERENCE_WORLD
speed	float64		jog speed [%] (1~100)

7.2 Service/motion

7.2.1 Trans.srv

▪ Features

- Input parameter(pos) based on the ref coordinate is translated/rotated as delta based on the same coordinate and this function returns the result that is converted to the value based on the ref_out coordinate.
- In case that the ref coordinate is the tool coordinate, this function returns the value based on input parameter(pos)'s coordinate without ref_out coordinate.

▪ Parameters

Parameter Name	Data Type	Default Value	Description
pos	float64[6]	-	position list
delta	float64[6]	-	position list
ref	int8	None	<ul style="list-style-type: none"> • MOVE_REFERENCE_BASE =0 • MOVE_REFERENCE_TOOL=1 • MOVE_REFERENCE_WORLD=2 • MOVE_REFERENCE_USER=101~120
ref_out	int8	DR_BASE	<ul style="list-style-type: none"> • MOVE_REFERENCE_BASE =0 • MOVE_REFERENCE_WORLD=2 • MOVE_REFERENCE_USER=101~120

Note

- The ref argument DR_WORLD is only available in M2.40 or later versions.
- The ref_out argument is only available in M2.40 or later versions.

▪ Return

Parameter Name	Data Type	Default Value	Description
trans_pos	float64[6]	-	Task space point
success	bool	-	True or False

7.2.2 Fkin.srv

▪ Features

This service receives the input data of joint angles or equivalent forms (float[6]) in the joint space and returns the TCP (objects in the task space) based on the ref coordinate.

▪ Parameters

Parameter Name	Data Type	Default Value	Description
pos	float64[6]	-	Joint Space position list
ref	int8	0	<ul style="list-style-type: none">• MOVE_REFERENCE_BASE =0• MOVE_REFERENCE_WORLD=2

Note

- The ref argument is only available in M2.40 or later versions.

▪ Return

Parameter Name	Data Type	Default Value	Description
conv_posx	float64[6]	-	Task space point
success	bool	-	True or False

7.2.3 Ikin.srv

▪ Features

This service returns the joint position corresponding to `sol_space`, which is equivalent to the robot pose in the operating space, among 8 joint shapes.

▪ Parameters

Parameter Name	Data Type	Default Value	Description
pos	float64[6]	-	position list
sol_space	int	-	solution space
ref	int	0	<ul style="list-style-type: none"> • MOVE_REFERENCE_BASE =0 • MOVE_REFERENCE_WORLD=2

Note

- The ref argument is only available in M2.40 or later versions.

▪ Robot configuration vs. solution space

Solution space	Binary	Shoulder	Elbow	Wrist
0	000	Lefty	Below	No Flip
1	001	Lefty	Below	Flip
2	010	Lefty	Above	No Flip
3	011	Lefty	Above	Flip
4	100	Righty	Below	No Flip
5	101	Righty	Below	Flip
6	110	Righty	Above	No Flip

▪ Return

Parameter Name	Data Type	Default Value	Description
conv_posj	float64[6]	-	joint angle list
success	bool	-	True or False



7.2.4 SetRefCoord.srv

▪ Features

This service sets the reference coordinate system.

▪ Parameters

Parameter Name	Data Type	Default Value	Description
coord	int	-	<ul style="list-style-type: none">• MOVE_REFERENCE_BASE =0• MOVE_REFERENCE_TOOL=1• MOVE_REFERENCE_WORLD=2• MOVE_REFERENCE_USER=101~120

Note

- The MOVE_REFERENCE_WORLD argument of ref is only available in M2.40 or later versions.

▪ Return

Parameter Name	Data Type	Default Value	Description
success	bool	-	True or False

7.2.5 MoveJoint.srv

▪ Features

The robot moves to the target joint position (pos) from the current joint position.

▪ Parameters

Parameter Name	Data Type	Default Value	Description
pos	float64[6]	-	joint angle list
vel	float64	-	velocity
acc	float64	-	acceleration
time	float64	0.0	Reach time [sec]
radius	float64	0.0	Radius for blending
mode	int8	0	Movement basis <ul style="list-style-type: none"> • MOVE_MODE_ABSOLUTE =0 • MOVE_MODE_RELATIVE =1
blendType	int8	0	Reactive motion mode <ul style="list-style-type: none"> • BLENDING_SPEED_TYPE_DUPLICATE =0 • BLENDING_SPEED_TYPE_OVERRIDE =1
syncType	int8	0	<ul style="list-style-type: none"> • SYNC = 0 • ASYNC = 1

Note

- If the time is specified, values are processed based on time, ignoring vel and acc.

Caution

If the following motion is blended with the conditions of blendType =BLENDING_SPEED_TYPE_BUPLICATE and radius>0, the preceding motion can be terminated when the following motion is terminated while the remaining motion time determined by the remaining distance, velocity, and acceleration of the preceding motion is greater than the motion time of the following motion. Refer to the following image for more information.

< (Example) Path differences accord. to 1st and 2nd motion settings >

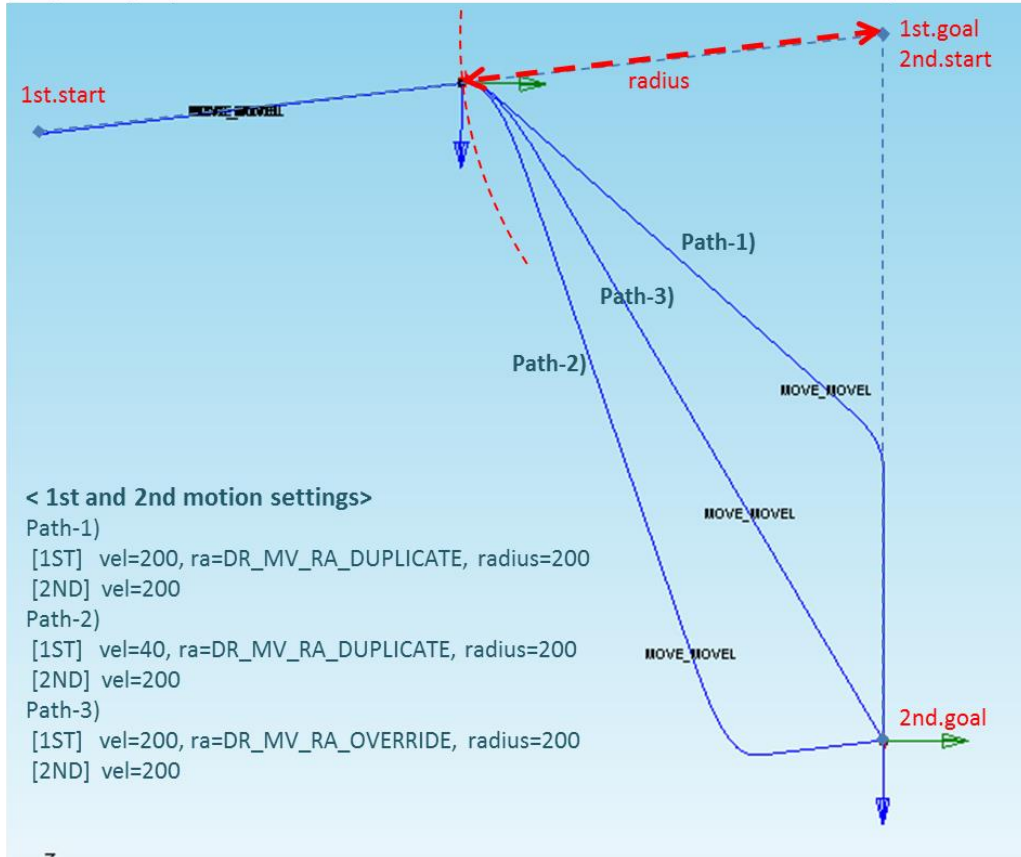

Return

Return Name	Data Type	Default Value	Description
success	bool	-	True or False

7.2.6 MoveLine.srv

▪ Features

The robot moves along the straight line to the target position (pos) within the task space.

▪ Parameters

Parameter Name	Data Type	Default Value	Description
pos	float64[6]	-	position list
vel	float64[2]	-	linear velocity, angular velocity
acc	float64[2]	-	linear acceleration, angular acceleration
time	float64	0.0	Reach time [sec] * If the time is specified, values are processed based on time, ignoring vel and acc.
radius	float64	0.0	Radius for blending
ref	int8	0	reference coordinate <ul style="list-style-type: none"> • MOVE_REFERENCE_BASE =0 • MOVE_REFERENCE_TOOL=1 • MOVE_REFERENCE_WORLD=2
mode	int8	0	Movement basis <ul style="list-style-type: none"> • MOVE_MODE_ABSOLUTE =0 • MOVE_MODE_RELATIVE =1
blendType	int8	0	Reactive motion mode <ul style="list-style-type: none"> • BLENDING_SPEED_TYPE_DUPLICATE =0 • BLENDING_SPEED_TYPE_OVERRIDE =1
syncType	int8	0	<ul style="list-style-type: none"> • SYNC = 0 • ASYNC = 1

Note

- If an argument is inputted to vel (e.g., vel=30), the input argument corresponds to the linear velocity of the motion while the angular velocity is determined proportionally to the linear velocity.

- If an argument is inputted to acc (e.g., acc=60), the input argument corresponds to the linear acceleration of the motion while the angular acceleration is determined proportionally to the linear acceleration.
- If the time is specified, values are processed based on time, ignoring vel and acc
- The MOVE_REFERENCE_WORLD argument of ref is only available in M2.40 or later versions.

Caution

If the following motion is blended with the conditions of blendType = BLENDING_SPEED_TYPE_DUPLICATEE and radius>0, the preceding motion can be terminated when the following motion is terminated while the remaining motion time determined by the remaining distance, velocity, and acceleration of the preceding motion is greater than the motion time of the following motion. Refer to the following image for more information.

< (Example) Path differences accord. to 1st and 2nd motion settings >

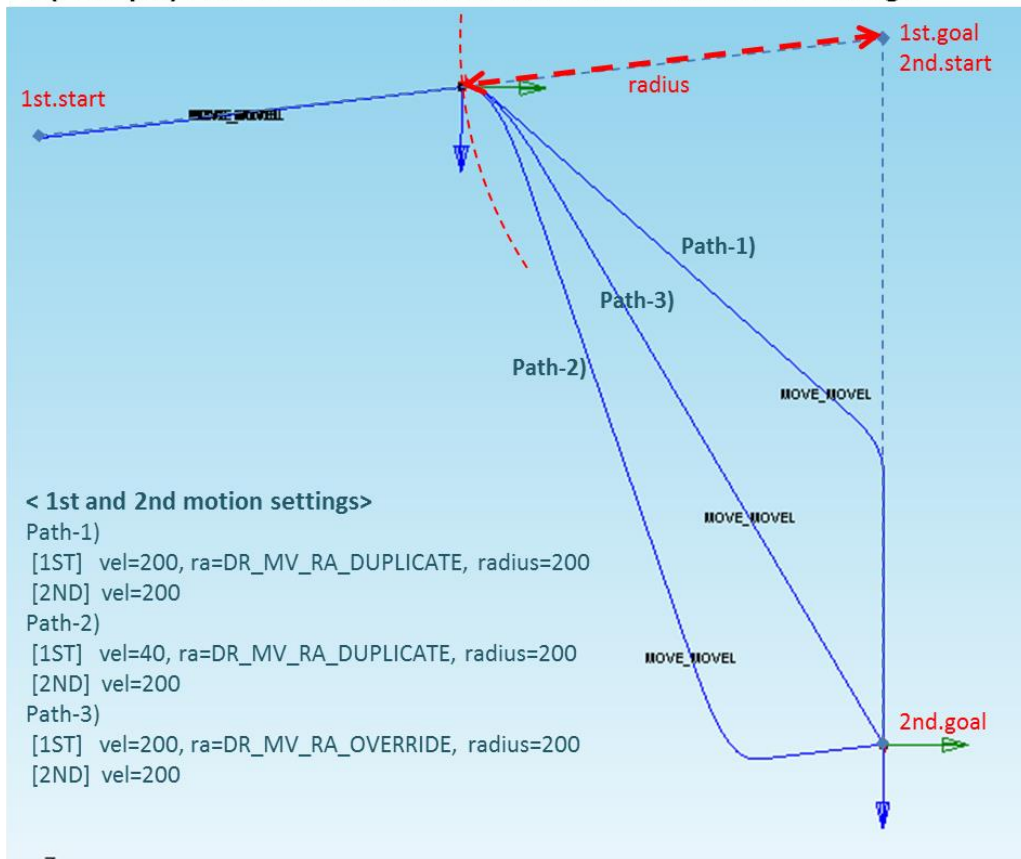



▪ **Return**

Return Name	Data Type	Default Value	Description
success	bool	-	True or False

7.2.7 MoveJointx.srv

▪ Features

The robot moves to the target position (pos) within the joint space.

Since the target position is inputted as a posx form in the task space, it moves in the same way as moveL. However, since this robot motion is performed in the joint space, it does not guarantee a linear path to the target position. In addition, one of 8 types of joint combination (robot configurations) corresponding to the task space coordinate system (posx) must be specified in sol (solution space).

▪ Parameters

Parameter Name	Data Type	Default Value	Description
pos	float64[6]	-	position list
vel	float64	-	velocity
acc	float64	-	acceleration
time	float64	0.0	Reach time [sec]
radius	float64	0.0	Radius for blending
ref	int8	0	reference coordinate <ul style="list-style-type: none"> • MOVE_REFERENCE_BASE =0 • MOVE_REFERENCE_TOOL=1 • MOVE_REFERENCE_WORLD=2
mode	int8	0	Movement basis <ul style="list-style-type: none"> • MOVE_MODE_ABSOLUTE =0 • MOVE_MODE_RELATIVE =1
blendType	int8	0	Reactive motion mode <ul style="list-style-type: none"> • BLENDING_SPEED_TYPE_DUPLICATE =0 • BLENDING_SPEED_TYPE_OVERRIDE =1
sol	int8	0	Solution space
syncType	int8	0	<ul style="list-style-type: none"> • SYNC = 0 • ASYNC = 1

 Note

- If the time is specified, values are processed based on time, ignoring vel and acc.
- Using the blending in the preceding motion generates an error in the case of input with relative motion (eMoveMode = MOVE_MODE_RELATIVE), and it is recommended to blend using MoveJoint or MoveLine
- **The MOVE_REFERENCE_WORLD argument of ref is only available in M2.40 or later versions.**
- Refer to the description of MoveJoint.srv and MoveLine.srv for blending according to option ra and vel/acc.

▪ Robot configuration (shape vs. solution space)

Solution space	Binary	Shoulder	Elbow	Wrist
0	000	Lefty	Below	No Flip
1	001	Lefty	Below	Flip
2	010	Lefty	Above	No Flip
3	011	Lefty	Above	Flip
4	100	Righty	Below	No Flip
5	101	Righty	Below	Flip
6	110	Righty	Above	No Flip
7	111	Righty	Above	Flip

▪ Return

Return Name	Data Type	Default Value	Description
success	bool	-	True or False

7.2.8 MoveCircle.srv

▪ Features

The robot moves along an arc to the target pos (pos2) via a waypoint (pos1) or to a specified angle from the current position in the task space.

▪ Parameters

Parameter Name	Data Type	Default Value	Description
pos	std_msgs/Float64MultiArray[]	-	target[2][6] <ul style="list-style-type: none"> position list
vel	float64[2]	-	linear velocity, angular velocity
acc	float64[2]	-	linear acceleration, angular acceleration
time	float64	0.0	Reach time [sec]
radius	float64	0.0	Radius for blending
ref	int8	0	reference coordinate <ul style="list-style-type: none"> MOVE_REFERENCE_BASE =0 MOVE_REFERENCE_TOOL=1 MOVE_REFERENCE_WORLD=2
mode	int8	0	Movement basis <ul style="list-style-type: none"> MOVE_MODE_ABSOLUTE =0 MOVE_MODE_RELATIVE =1
angle1	float64	0.0	angle1
angle2	float64	0.0	angle2
blendType	int8	0	Reactive motion mode <ul style="list-style-type: none"> BLENDING_SPEED_TYPE_DUPLICATE =0 BLENDING_SPEED_TYPE_OVERRIDE =1
syncType	int8	0	<ul style="list-style-type: none"> SYNC = 0 ASYNC = 1

 Note

- If an argument is inputted to vel (e.g., vel=[30, 0]), the input argument corresponds to the linear velocity of the motion while the angular velocity is determined proportionally to the linear velocity.
- If an argument is inputted to acc (e.g., acc=[60, 0]), the input argument corresponds to the linear acceleration of the motion while the angular acceleration is determined proportionally to the linear acceleration.
- If the time is specified, values are processed based on time, ignoring vel and acc.
- **The MOVE_REFERENCE_WORLD argument of ref is only available in M2.40 or later versions.**
- If the mod is MOVE_MODE_RELATIVE L, pos[0] and pos[1] are defined in the relative coordinate system of the previous pos. (pos[0] is the relative coordinate from the starting point while pos[1] is the relative coordinate from pos[0].)
- If only one angle is inputted, the total rotated angle on the circular path is applied to the angle.
- If two angle values are inputted, angle1 refers to the total rotating angle moving at a constant velocity on the circular path while angle2 refers to the rotating angle in the rotating section for acceleration and deceleration. In that case, the total moving angle angle1 + 2 X angle2 moves along the circular path.

 **Caution**

If the following motion is blended with the conditions of blendType= BLENDING_SPEED_TYPE_DUPLICATE and radius>0, the preceding motion can be terminated when the following motion is terminated while the remaining motion time determined by the remaining distance, velocity, and acceleration of the preceding motion is greater than the motion time of the following motion. Refer to the following image for more information.

< (Example) Path differences accord. to 1st and 2nd motion settings >

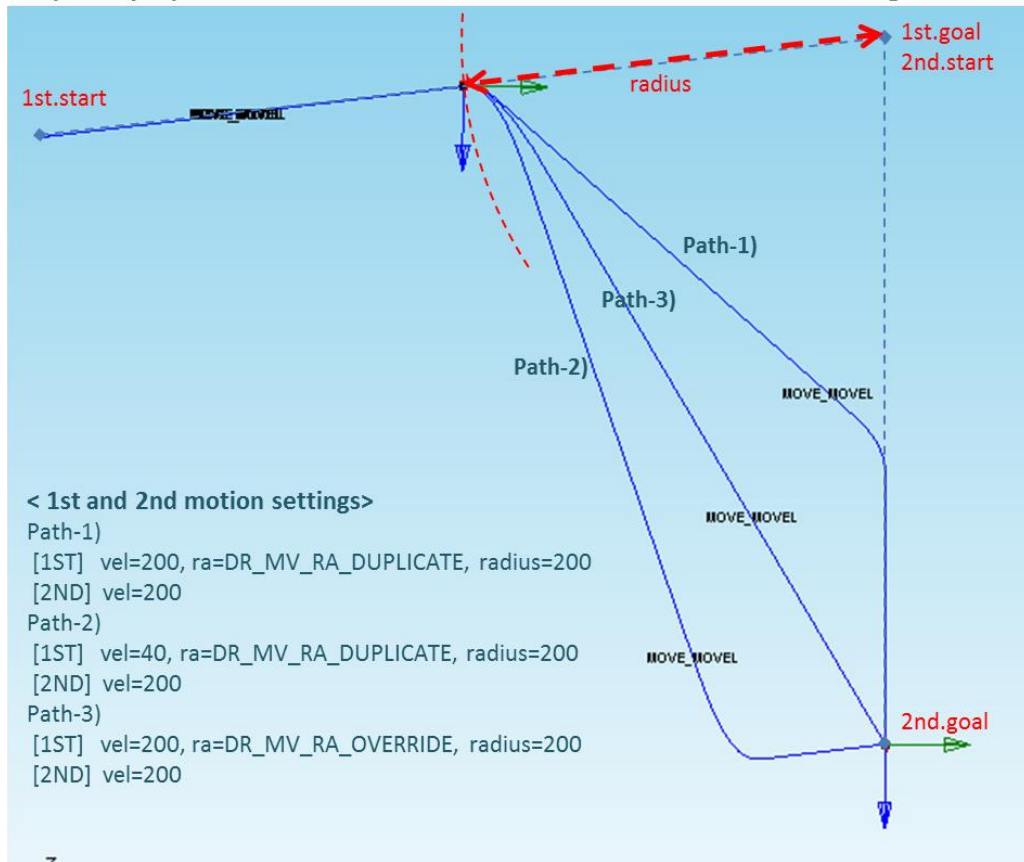

Return

Return Name	Data Type	Default Value	Description
success	bool	-	True or False

7.2.9 MoveSplineJoint.srv

▪ Features

The robot moves along a spline curve path that connects the current position to the target position (the last waypoint in position list) via the waypoints of the joint space input in position list.

The input velocity/acceleration means the maximum velocity/acceleration in the path, and the acceleration and deceleration during the motion are determined according to the position of the waypoint.

▪ Parameters

Parameter Name	Data Type	Default Value	Description
pos	std_msgs/Float64MultiArray[]	-	target pos [100][6] max = 100
posCnt	int8	-	Count of target pos
vel	float64	-	velocity
acc	float64	-	acceleration
time	float64	0.0	Reach time [sec]
mode	int8	0	Movement basis <ul style="list-style-type: none"> • MOVE_MODE_ABSOLUTE =0 • MOVE_MODE_RELATIVE =1
syncType	int8	0	<ul style="list-style-type: none"> • SYNC = 0 • ASYNC = 1

Note

- If the time is specified, values are processed based on time, ignoring vel and acc.
- If the mod is MOVE_MODE_RELATIVE, each pos in the pos_list is defined in the relative coordinate of the previous pos. (If pos_list=[q1, q2, ...,q(n-1), q(n)], q1 is the relative angle of the starting point while q(n) is the relative coordinate of q(n-1).)
- This service does not support online blending of previous and subsequent motions.

- **Return**

Return Name	Data Type	Default Value	Description
success	bool	-	True or False

7.2.10 MoveSplineTask.srv

▪ Features

The robot moves along a spline curve path that connects the current position to the target position (the last waypoint in position list) via the waypoints of the task space input in pos_list.

The input velocity/acceleration means the maximum velocity/acceleration in the path and the constant velocity motion is performed with the input velocity according to the condition if the option for the constant speed motion is selected.

▪ Parameters

Parameter Name	Data Type	Default Value	Description
pos	std_msgs/Float64MultiArray[]	-	target pos [100][6] max = 100
posCnt	int8	-	Count of target pos
vel	float64[2]	-	linear velocity, angular velocity
acc	float64[2]	-	linear acceleration, angular acceleration
time	float64	0.0	Reach time [sec]
ref	int8	0	reference coordinate <ul style="list-style-type: none"> • MOVE_REFERENCE_BASE =0 • MOVE_REFERENCE_TOOL=1 • MOVE_REFERENCE_WORLD=2
mode	int8	0	Movement basis <ul style="list-style-type: none"> • MOVE_MODE_ABSOLUTE =0 • MOVE_MODE_RELATIVE =1
opt	int8	0	Velocity option <ul style="list-style-type: none"> • SPLINE_VELOCITY_OPTION_DEFAULT=0 • SPLINE_VELOCITY_OPTION_CONSTANT=1

Parameter Name	Data Type	Default Value	Description
syncType	int8	0	<ul style="list-style-type: none"> • SYNC = 0 • ASYNC = 1

 Note

- If an argument is inputted to vel (e.g., vel=[30, 0]), the input argument corresponds to the linear velocity of the motion while the angular velocity is determined proportionally to the linear velocity.
- If an argument is inputted to acc (e.g., acc=[60, 0]), the input argument corresponds to the linear acceleration of the motion while the angular acceleration is determined proportionally to the linear acceleration.
- If the time is specified, values are processed based on time, ignoring vel and acc.
- **The MOVE_REFERENCE_WORLD argument of ref is only available in M2.40 or later versions.**
- If the mod is MOVE_MODE_RELATIVE, each pos in the pos_list is defined in the relative coordinate of the previous pos. (If posiolist=[p1, p2, ...,p(n-1), p(n)], p1 is the relative angle of the starting point while p(n) is the relative coordinate of p(n-1).)
- This service does not support online blending of previous and subsequent motions.

 Caution

The constant velocity motion according to the distance and velocity between the waypoints cannot be used if the "opt= SPLINE_VELOCITY_OPTION_CONST" option (constant velocity option) is selected, and the motion is automatically switched to the variable velocity motion (opt= SPLINE_VELOCITY_OPTION_DEFAULT) in that case.

▪ Return

Return Name	Data Type	Default Value	Description
success	bool	-	True or False

7.2.11 MoveBlending.srv

▪ Features

This function takes a list that has one or more path segments (line or circle) as arguments and moves at a constant velocity by blending each segment into the specified radius. Here, the radius can be set through posb.

▪ Parameters

Parameter Name	Data Type	Default Value	Description
pos	std_msgs/Float64MultiArray[]	-	posb list (pos1[6]:pos2[6]:type[1]:radius[1]) x 50(max)
posCnt	int8		Count of target pos
vel	float64[2]	-	linear velocity, angular velocity
acc	float64[2]	-	linear acceleration, angular acceleration
time	float64	0.0	Reach time [sec]
ref	int8	0	Reference coordinate <ul style="list-style-type: none"> • MOVE_REFERENCE_BASE =0 • MOVE_REFERENCE_TOOL=1 • MOVE_REFERENCE_WORLD=2
mode	int8	0	Movement basis <ul style="list-style-type: none"> • MOVE_MODE_ABSOLUTE =0 • MOVE_MODE_RELATIVE =1
syncType	int8	0	<ul style="list-style-type: none"> • SYNC = 0 • ASYNC = 1

Note

- If an argument is inputted to vel (e.g., vel=[30, 0]), the input argument corresponds to the linear velocity of the motion while the angular velocity is determined proportionally to the linear velocity.
- If an argument is inputted to acc (e.g., acc=[60, 0]), the input argument corresponds to the linear acceleration of the motion while the angular acceleration is determined proportionally to the linear acceleration.
- If the time is specified, values are processed based on time, ignoring vel and acc.

- The `MOVE_REFERENCE_WORLD` argument of `ref` is only available in M2.40 or later versions.
- If the `mod` is `MOVE_MODE_RELATIVE`, each `pos` in the `posb_list` is defined in the relative coordinate of the previous `pos`.

 **Caution**

- A user input error is generated if the blending radius in `posb` is 0.
- A user input error is generated due to the duplicated input of Line if contiguous Line-Line segments have the same direction.
- A user input error is generated to prevent a sudden acceleration if the blending condition causes a rapid change in direction.
- This service does not support online blending of previous and subsequent motions

▪ **Return**

Return Name	Data Type	Default Value	Description
success	bool	-	True or False

7.2.12 MoveSpiral.srv

▪ Features

The radius increases in a radial direction and the robot moves in parallel with the rotating spiral motion in an axial direction. It moves the robot along the spiral trajectory on the surface that is perpendicular to the axis on the coordinate specified as ref and the linear trajectory in the axis direction.

▪ Parameters

Parameter Name	Data Type	Default Value	Description
revolution	float64	-	Total number of revolutions [revolution]
maxRadius	float64		Final spiral radius [mm]
maxLength	float64		Distance moved in the axis direction [mm]
vel	float64[2]	-	linear velocity, angular velocity
acc	float64[2]	-	linear acceleration, angular acceleration
time	float64	0.0	Total execution time [sec]
taskAxis	int8	0	axis <ul style="list-style-type: none"> • TASK_AXIS_X = 0 • TASK_AXIS_Y = 1 • TASK_AXIS_Z = 2
ref	int8	0	reference coordinate <ul style="list-style-type: none"> • MOVE_REFERENCE_BASE = 0 • MOVE_REFERENCE_TOOL = 1 • MOVE_REFERENCE_WORLD = 2
syncType	int8	0	<ul style="list-style-type: none"> • SYNC = 0 • ASYNC = 1

Note

- Revolution refers to the maximum radius of the spiral motion.
- Rmax refers to the maximum radius of the spiral motion.
- Lmax refers to the parallel distance in the axis direction during the motion. A negative value means the parallel distance in the -axis direction.

- Vel refers to the moving velocity of the spiral motion
- If the time is specified, values are processed based on time, ignoring vel and acc.
- The `MOVE_REFERENCE_WORLD` argument of `ref` is only available in M2.40 or later versions.
- The axis defines the axis that is perpendicular to the surface defined by the spiral motion.
- Ref refers to the reference coordinate system defined by the spiral motion.
- This service does not support online blending of previous and subsequent motions.

 **Caution**

- An error can be generated to ensure safe motion if the rotating acceleration calculated by the spiral path is too great.
In this case, reduce the vel, acc, or time value.

▪ **Return**

Return Name	Data Type	Default Value	Description
success	bool	-	True or False

7.2.13 MovePeriodic.srv

▪ Features

This function performs the cyclic motion based on the sine function of each axis (parallel and rotation) of the reference coordinate (ref) input as a relative motion that begins at the current position. The attributes of the motion on each axis are determined by the amplitude and period, and the acceleration/deceleration time and the total motion time are set by the interval and repetition count.

▪ Parameters

Parameter Name	Data Type	Default Value	Description
amp	float64[6]	-	Amplitude (motion between -amp and +amp) [mm] or [deg]
periodic	float64[6]	-	Period (time for 1 cycle) [sec]
acc	float64	-	Acceleration
time	float64	-	Acc-, dec- time [sec]
repeat	int8	-	Repetition count
ref	int8	0	reference coordinate <ul style="list-style-type: none"> • MOVE_REFERENCE_BASE =0 • MOVE_REFERENCE_TOOL=1 • MOVE_REFERENCE_WORLD=2
syncType	int8	0	<ul style="list-style-type: none"> • SYNC = 0 • ASYNC = 1

Note

- Amp refers to the amplitude. The input is a list of 6 elements which are the amp values for the axes (x, y, z, rx, ry, and rz). The amp input on the axis that does not have a motion must be 0.
- Period refers to the time needed to complete a motion in the direction, the amplitude. The input is a list of 6 elements which are the periods for the axes (x, y, z, rx, ry, and rz).
- Atime refers to the acceleration and deceleration time at the beginning and end of the periodic motion. The largest of the inputted acceleration/deceleration times and maximum period*1/4 is applied. An error is generated when the inputted acceleration/deceleration time exceeds 1/2 of the total motion time.

- Repeat refers to the number of repetitions of the axis (reference axis) that has the largest period value and determines the total motion time. The number of repetitions for each of the remaining axes is determined automatically according to the motion time.
- If the motion terminates normally, the motions for the remaining axes can be terminated before the reference axis's motion terminates so that the end position matches the starting position. The deceleration section will deviate from the previous path if the motions of all axes are not terminated at the same time. Refer to the following image for more information

CASE-1) All-axis motions end at the same time

`move_periodic(amp=[100,100,0,0,0,0], period=[3.2,1.6,0,0,0,0], atime=3.1, repeat=2, ref=DR_BASE)`

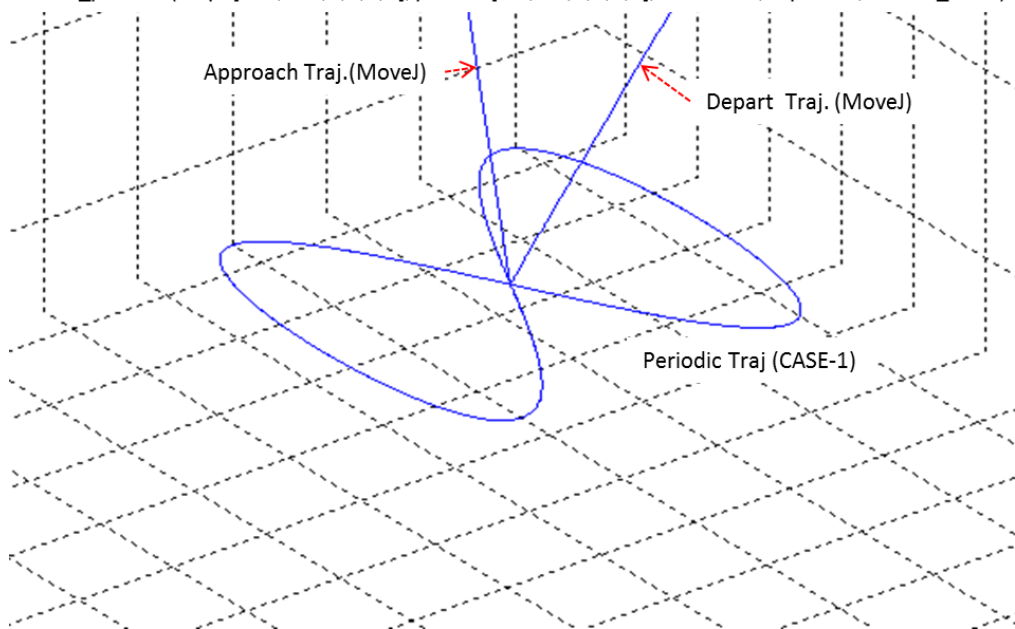

CASE-2) Diff-axis motions end individually

`move_periodic(amp=[100,100,0,0,0,0], period=[3.2,1.5,0,0,0,0], atime=0, repeat=2, ref=DR_BASE)`

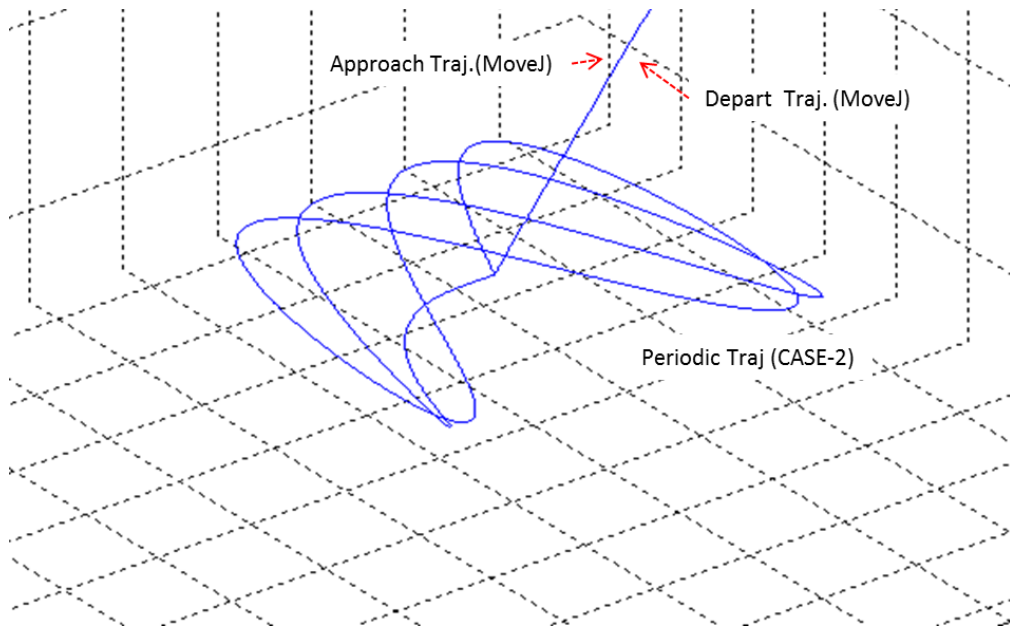

- ref refers to the reference coordinate system of the repeated motion.
- **The MOVE_REFERENCE_WORLD argument of ref is only available in M2.40 or later versions.**
- If a maximum velocity error is generated during a motion, adjust the amplification and period using the following formula.
Max. velocity = Amplification(amp)*2*pi(3.14)/Period(period) (i.e., Max. velocity=62.83mm/sec if amp=10mm and period=1 sec)
- This function does not support online blending of previous and subsequent motions.

▪ **Return**

Return Name	Data Type	Default Value	Description
success	bool	-	True or False

7.2.14 MoveWait.srv

- **Features**

This service sets the waiting time between the previous motion command and the motion command in the next line.

- **Parameters**

Parameter Name	Data Type	Default Value	Description
N/A	-	-	-

- **Return**

Return Name	Data Type	Default Value	Description
success	bool	-	True or False

7.2.15 MovePause.srv

- **Features**

It is a service to decelerate and pause the motion of the current robot.

If no robot motion is in progress, it is ignored.

- **Parameters**

Parameter Name	Data Type	Default Value	Description
N/A	-	-	-

- **Return**

Return Name	Data Type	Default Value	Description
success	bool	-	True or False

7.2.16 MoveResume.srv

- **Features**

Service to resume the motion of a suspended robot.
If no robot path motion is in progress, it is ignored.

- **Parameters**

Parameter Name	Data Type	Default Value	Description
N/A	-	-	-

- **Return**

Return Name	Data Type	Default Value	Description
success	bool	-	True or False



7.2.17 MoveStop.srv

- **Features**

Service to stop robot motion.

It stops differently depending on the input parameters.

- **Parameters**

Parameter Name	Data Type	Default Value	Description
Stop_mode	int32	-	0 : reserved 1 : quick stop (keep motion trajectory) 2 : slow stop (keep motion trajectory)

- **Return**

Return Name	Data Type	Default Value	Description
success	bool	-	True or False

7.2.18 Jog.srv

▪ Features

This service is for performing jog motion control for each axis of the robot.

▪ Parameters

Parameter Name	Data Type	Default Value	Description
Jog_axis	int8	-	0 ~ 5 : JOINT 1 ~ 6 6 ~ 11: TASK 1 ~ 6 (X,Y,Z,rx,ry,rz)
move_reference	int8	-	0 : MOVE_REFERENCE_BASE 1 : MOVE_REFERENCE_TOOL
speed	float64	-	jog speed [%] : + forward , 0=stop, - backward

▪ Return

Return Name	Data Type	Default Value	Description
success	bool	-	True or False

7.2.19 JogMulti.srv

▪ Features

This is a service to perform jog control on multiple axes of robots in the robot controller.

Multi-axis jog speed = (250mm / s) / $\sqrt{3}$ x [unit vector] x speed [%]

Caution

This service is available with robot controller software version 2.50 or later.

▪ Parameters

Parameter Name	Data Type	Default Value	Description
jog_axis	float64[6]	-	Unit vector direction of task space [Tx, Ty, Tz, Rx, Ry, Rz] (-1.0 ~ 1.0)
move_reference	int8	-	0: MOVE_REFERENCE_BASE 1: MOVE_REFERENCE_TOOL: 2: MOVE_REFERENCE_WORLD
speed	float64		jog speed [%] (1~100)

▪ Return

Return Name	Data Type	Default Value	Description
success	bool	-	True or False

7.2.20 CheckMotion.srv

- **Features**

This service checks the status of the currently active motion..

- **Parameters**

Not applicable

- **Return**

Parameter Name	Data Type	Default Value	Description
status	int8	-	0 : No motion in action 1 : nituib being calculated 2 : motion is operation
success	bool	-	True or False



7.2.21 ChangeOperationSpeed.srv

- **Features**

This service adjusts the operation velocity. The argument is the relative velocity in a percentage of the currently set velocity and has a value from 1 to 100. Therefore, a value of 50 means that the velocity is reduced to 50% of the currently set velocity.

- **Parameters**

Parameter Name	Data Type	Default Value	Description
speed	int8	-	operation speed(1~100)

- **Return**

Parameter Name	Data Type	Default Value	Description
success	bool	-	True or False

7.2.22 EnableAlterMotion.srv

▪ Features

This service is only available for M2.40 or later versions.

enable_alter_motion() and alter_motion() services enable to alter motion trajectory.

This function sets the configurations for altering function and allows the input quantity of alter_motion() to be applied to motion trajectory. The unit cycle time of generating alter motion is 100msec. Cycle time($n \times 100\text{msec}$) can be changed through input parameter n. This function provide 2 modes(Accumulation mode, Increment mode). Input quantity of alter_motion() can be applied to motion trajectory in two ways as accumulated value or increment value. In accumulation mode, the input quantity means absolute altering amount(dX,dY,dZ,dRX,dRY,dRZ) from current motion trajectory. On the contrary in increment mode, the quantity means increment value from the previous absolute altering amount. The reference coordinate can be changed through input parameter ref. Limitations of accumulation amount and increment amount can be set through input paramet limit_dPOS (accumulated limit) and limit_dPOS_per(increment input limit during 1 cycle). The actual alter amount is limited to these limits.

▪ Parameters

Parameter Name	Data Type	Default Value	Description
n	int32	-	Cycle time number
mode	Int8	-	<ul style="list-style-type: none"> • PATH_MODE_DPOS = 0 • PATH_MODE_DVEL = 1
ref	int8	-	<ul style="list-style-type: none"> • MOVE_REFERENCE_BASE = 0 • MOVE_REFERENCE_TOOL = 1 • MOVE_REFERENCE_WORLD = 2 • MOVE_REFERENCE_USER = 101~120
limit_dPOS	float64[2]	-	First value : limitation of position[mm] Second value : limitation of orientation[deg]
limit_dPOS_per	float64[2]	-	First value : limitation of position[mm] Second value : limitation of orientation[deg]

Note

- _global_ref is applied if ref is None
- Accumulation amount or increment amount isn't be limited if limit_dPOS or limit_dPOS_per is None.
- alter_motion() can be executed only in user thread.



▪ **Return**

Parameter Name	Data Type	Default Value	Description
success	bool	-	True or False

7.2.23 AlterMotion.srv

▪ Features

This service is only available for M2.40 or later versions.

This service applies altering amount of motion trajectory when the alter function is activated. The meaning of the input values is defined from `enable_alter_motion()`.

Caution

- `alter_motion()` can be executed only in user thread.

Note

- `alter_motion()` can be executed only in user thread.
- Alter motion can be adjusted through setting value `limit_dPOS` or `limit_dPOS_per` in `enable_alter_motion` function.
- Orientation of Input pose follows fixed XYZ notation.

▪ Parameters

Parameter Name	Data Type	Default Value	Description
<code>pos</code>	<code>float64[6]</code>	-	position list

▪ Return

Parameter Name	Data Type	Default Value	Description
<code>success</code>	<code>bool</code>	-	True or False



7.2.24 DisableAlterMotion.srv

- **Features**

This service is only available for M2.40 or later versions.

This service deactivates alter motion.

- **Parameters**

Not applicable

- **Return**

Parameter Name	Data Type	Default Value	Description
success	bool	-	True or False

7.3 Service/system

7.3.1 GetRobotMode.srv

▪ Features

It is a service input for checking the current operation mode of the robot controller. The auto mode is a mode for automatically performing a series of operations (programs), and the manual mode is for performing a single operation such as jogging.

▪ Parameters

None

▪ Return

Return Name	Data Type	Default Value	Description
Robot_mode	int8	-	refer to enum.ROBOT_MODE.
success	bool	-	True or False

▪ enum.ROBOT_MODE

Num	name	Description
0	ROBOT_MODE_MANUAL	Manual mode
1	ROBOT_MODE_AUTONOMOUS	Auto mode
2	ROBOT_MODE_MEASURE	Measure mode (Not currently supported)



7.3.2 SetRobotMode.srv

▪ Features

This service is for setting the current operation mode of the robot controller.

▪ Parameters

Parameter Name	Data Type	Default Value	Description
robot_mode	int8	-	refer to enum.ROBOT_MODE

▪ Return

Return Name	Data Type	Default Value	Description
success	bool	-	True or False

▪ enum.ROBOT_MODE

Num	name	Description
0	ROBOT_MODE_MANUAL	Manual mode
1	ROBOT_MODE_AUTONOMOUS	Auto mode
2	ROBOT_MODE_MEASURE	Measure mode (Not currently supported)

7.3.3 GetRobotSystem.srv

▪ Features

It is a service input for confirming the current operation mode (virtual robot, actual robot) of the robot controller.

▪ Parameters

None

▪ Return

Return Name	Data Type	Default Value	Description
robot_system	int8	-	refer to enum.ROBOT_SYSTEM
success	bool	-	True or False

▪ enum.ROBOT_SYSTEM

Num	name	Description
0	ROBOT_SYSTEM_REAL	Actual robot system
1	ROBOT_SYSTEM_VIRTUAL	virtual robot system

7.3.4 SetRobotSystem.srv

- **Features**

This is a service for setting up the current robot system of the robot controller.

- **Parameters**

Parameter Name	Data Type	Default Value	Description
robot_system	int8	-	refer to enum.ROBOT_SYSTEM

- **Return**

Return Name	Data Type	Default Value	Description
success	bool	-	True or False

- **enum.ROBOT_SYSTEM**

Num	name	Description
0	ROBOT_SYSTEM_REAL	Actual robot system
1	ROBOT_SYSTEM_VIRTUAL	virtual robot system

7.3.5 GetRobotSpeedMode.srv

▪ Features

This service is used to check the current speed mode (normal mode, deceleration mode) from the robot controller.

▪ Parameters

None

▪ Return

Return Name	Data Type	Default Value	Description
Speed_mode	int8	-	refer to enum.SPEED_MODE
success	bool	-	True or False

▪ enum.SPEED_MODE

Num	name	Description
0	SPEED_NORMAL_MODE	Normal speed mode
1	SPEED_REDUCED_MODE	deceleration speed mode

7.3.6 SetRobotSpeedMode.srv

▪ Features

This service is used to set and change the currently operating speed mode of the robot controller.

▪ Parameters

Parameter Name	Data Type	Default Value	Description
speed_mode	int8	-	refer to enum.SPEED_MODE

▪ Return

Return Name	Data Type	Default Value	Description
success	bool	-	True or False

▪ enum.SPEED_MODE

Num	name	Description
0	SPEED_NORMAL_MODE	Normal speed mode
1	SPEED_REDUCED_MODE	deceleration speed mode

7.3.7 SetSafeStopResetType.srv

▪ Features

This service is used to define a series of actions to be executed automatically after the state transition using the SetRobotMode service when the operation status information of the robot controller is SAFE_STOP.

If the robot operation mode is automatic, you can define and set whether to re-execute the program. In manual mode, this setting is ignored.

▪ Parameters

Parameter Name	Data Type	Default Value	Description
reset_type	int8	-	refer to enum.SAFE_STOP_RESET_TYPE

▪ Return

Return Name	Data Type	Default Value	Description
success	bool	-	True or False

▪ enum.SAFE_STOP_RESET_TYPE

Num	name	Description
0	SAFE_STOP_RESET_TYPE_DEFAULT	Simple state release (manual mode)
	SAFE_STOP_RESET_TYPE_PROGRAM_STOP	Stop program (autoc mode)
1	SAFE_STOP_RESET_TYPE_PROGRAM_RESUME	Restart the program (automatic mode)

7.3.8 GetCurrentPose.srv

▪ Features

This service is used to check the current position information of each axis of the robot according to the coordinate system (joint space or task space) in the robot controller.

▪ Parameters

Parameter Name	Data Type	Default Value	Description
space_type	int8	-	refer to enum.ROBOT_SPACE

▪ Return

Return Name	Data Type	Default Value	Description
pos	float64[6]	-	Robot position information
success	bool	-	True or False

▪ enum.ROBOT_SPACE

Num	name	Description
0	ROBOT_SPACE_JOINT	Joint space
1	ROBOT_SPACE_TASK	task space

7.3.9 GetLastAlarm.srv

▪ Features

This service is used to check the most recent log and alarm codes generated by the robot controller.

▪ Parameters

None

▪ Return

Return Name	Data Type	Default Value	Description
log_alarm	LogAlarm.msg	-	refet to LogAlam.msg
success	bool	-	True or False

▪ LogAlam.msg

Parameter Name	Data Type	Default Value	Description
level	int32	-	refet to enum.LOG_LEVEL
group	int32	-	refet to enum.LOG_GROUP
index	int32	-	error code
param	string[3]	-	param[3]

enum.LOG_LEVEL

Num	name	Description
0	LOG_LEVEL_RESERVED	reserved
1	LOG_LEVEL_SYSINFO	Informational messages about basic functions and operational errors
2	LOG_LEVEL_SYSWARN	Robot is stopped due to basic function and operation error
3	LOG_LEVEL_SYSERROR	Robot is stopped due to safety issue or device error



enum.LOG_GROUP

Num	name	Description
0	LOG_GROUP_RESERVED	reserved
1	LOG_GROUP_SYSTEMFMK	framework
2	eLOG_GROUP_MOTIONLIB,	Motion algorithm
3	LOG_GROUP_SMARTTP	TP program (GUI)
4	LOG_GROUP_INVERTER	Robot Inverter Board
5	LOG_GROUP_SAFETYCONTROLLER	Safety Controller

The log and alarm messages are passed through the predefined contents through the number, and the relevant parameters are sent together if necessary.

Please refer to log and alarm definition section for details.

7.4 Service/aux_control

7.4.1 GetControlMode.srv

- **Features**

This service returns the current control mode.

- **Parameters**

Not applicable

- **Return**

Parameter Name	Data Type	Default Value	Description
control_mode	int8	-	Control mode 3 : Position Control Mode 4 : Torque Control mode
success	bool	-	True or False



7.4.2 GetControlSpace.srv

- **Features**

This service returns the current control space.

- **Parameters**

Not applicable

- **Return**

Parameter Name	Data Type	Default Value	Description
space	int8	-	Control mode 1 : Joint space control 2 : Task space control
success	bool	-	True or False

7.4.3 GetCurrentPosj.srv

- **Feature**

This service returns the current joint angle.

- **Parameters**

Not applicable

- **Return**

Parameter Name	Data Type	Default value	Description
pos	float64[6]	-	Joint angle
success	bool	-	True or False



7.4.4 GetCurrentVelj.srv

- **Features**

This service returns the current joint velocity.

- **Parameters**

Not applicable

- **Return**

Parameter Name	Data Type	Default Value	Description
joint_speed	float64[6]	-	Joint Speed
success	bool	-	True or False

7.4.5 GetDesiredPosj.srv

- **Features**

This service returns the current target joint angle. It cannot be used in the `movej`, `movec`, `movesx`, `moveb`, `move_spiral`, or `move_periodic` command.

- **Parameters**

Not applicable

- **Return**

Parameter Name	Data Type	Default Value	Description
pos	float64[6]	-	Joint angle
success	bool	-	True or False



7.4.6 GetDesiredVelj.srv

- **Features**

This service returns the current target joint velocity. It cannot be used in the movel, movec, movesx, moveb, move_spiral, or move_periodic command.

- **Parameters**

Not applicable

- **Return**

Parameter Name	Data Type	Default Value	Description
joint_vel	float64[6]	-	target joint velocity
success	bool	-	True or False

7.4.7 GetCurrentPosx.srv

▪ Features

This service returns the pose and solution space of the current coordinate system. The pose is based on the ref coordinate.

▪ Parameters

Parameter Name	Data Type	Default Value	Description
ref	Int8	0	<ul style="list-style-type: none"> • MOVE_REFERENCE_BASE =0 • MOVE_REFERENCE_WORLD=2 • MOVE_REFERENCE_USER=101~120

Note

- ref: MOVE_REFERENCE_BASE (base coordinate)/user coordinate (globally declared user coordinate)
- MOVE_REFERENCE_BASE is applied when ref is omitted.
- **The MOVE_REFERENCE_WORLD argument of ref is only available in M2.40 or later versions.**

▪ Return

Parameter Name	Data Type	Default Value	Description
task_pos_info	std_msgs/Float64MultiArray[]	-	posx list : task_pos_info[0][0:5] solution space : task_pos_info[0][6]
success	bool	-	True or False

7.4.8 GetCurrentToolFlangePosx.srv

▪ Features

This service returns the pose of the current tool flange based on the ref coordinate. In other words, it means the return to tcp=(0,0,0,0,0,0).

▪ Parameters

Parameter Name	Data Type	Default Value	Description
ref	Int8	0	<ul style="list-style-type: none">• MOVE_REFERENCE_BASE =0• MOVE_REFERENCE_WORLD=2

Note

- **The ref argument is only available in M2.40 or later versions.**

▪ Return

Parameter Name	Data Type	Default Value	Description
pos	float64[6]	-	Pose of tool flange
success	bool	-	True or False

7.4.9 GetCurrentVelx.srv

▪ Features

This service returns the current tool velocity based on the ref coordinate.

▪ Parameters

Parameter Name	Data Type	Default Value	Description
ref	Int8	0	<ul style="list-style-type: none">• MOVE_REFERENCE_BASE =0• MOVE_REFERENCE_WORLD=2

Note

- **The ref argument is only available in M2.40 or later versions.**

▪ Return

Parameter Name	Data Type	Default Value	Description
vel	float64[6]	-	tool velocity

7.4.10 GetDesiredPosx.srv

▪ Features

This service returns the target pose of the current tool. The pose is based on the ref coordinate.

▪ Parameters

Parameter Name	Data Type	Default Value	Description
ref	Int8	0	<ul style="list-style-type: none"> • MOVE_REFERENCE_BASE =0 • MOVE_REFERENCE_WORLD=2 • MOVE_REFERENCE_USER=101~120

Note

- ref: MOVE_REFERENCE_BASE (base coordinate)/user coordinate (globally declared user coordinate)
- MOVE_REFERENCE_BASE is applied when ref is omitted.
- **The MOVE_REFERENCE_WORLD argument of ref is only available in M2.40 or later versions.**

▪ Return

Parameter Name	Data Type	Default Value	Description
pos	float64[6]	-	target tool position
success	bool	-	True or False

7.4.11 GetDesiredVelx.srv

▪ Features

This service returns the target velocity of the current tool based on the ref coordinate. It cannot be used in the movej, movejx, or movesj command.

▪ Parameters

Parameter Name	Data Type	Default Value	Description
ref	Int8	0	<ul style="list-style-type: none">• MOVE_REFERENCE_BASE =0• MOVE_REFERENCE_WORLD=2

Note

- ref: MOVE_REFERENCE_BASE (base coordinate)/user coordinate (globally declared user coordinate)
- MOVE_REFERENCE_BASE is applied when ref is omitted.
- **The MOVE_REFERENCE_WORLD argument of ref is only available in M2.40 or later versions.**

▪ Return

Parameter Name	Data Type	Default Value	Description
vel	float64[6]	-	tool velocity
success	bool	-	True or False

7.4.12 GetCurrentSolutionSpace

- **Features**

It is a service to get the the current solution space value..

- **Parameters**

None

- **Return**

Return Name	Data Type	Default Value	Description
solution_space	int8	-	solution space (0~7)
success	bool	-	True or False

- **Robot configuration (shape vs. solution space)**

Solution space	Binary	Shoulder	Elbow	Wrist
0	000	Lefty	Below	No Flip
1	001	Lefty	Below	Flip
2	010	Lefty	Above	No Flip
3	011	Lefty	Above	Flip
4	100	Righty	Below	No Flip
5	101	Righty	Below	Flip
6	110	Righty	Above	No Flip
7	111	Righty	Above	Flip

7.4.13 GetCurrentRotm.srv

▪ Features

This service returns the direction and matrix of the current tool based on the ref coordinate.

▪ Parameters

Parameter Name	Data Type	Default Value	Description
ref	Int8	0	<ul style="list-style-type: none">• MOVE_REFERENCE_BASE =0• MOVE_REFERENCE_WORLD=2

Note

- **The ref argument is only available in M2.40 or later versions.**

▪ Return

Parameter Name	Data Type	Default Value	Description
rot_matrix	std_msgs/Float64MultiArray[]	-	Rotation Matrix
success	bool	-	True or False



7.4.14 GetJointTorque.srv

- **Features**

This service returns the sensor torque value of the current joint.

- **Parameters**

None

- **Return**

Return Name	Data Type	Default Value	Description
joint_torque	float64[6]	-	JTS torque value
success	bool	-	True or False

7.4.15 GetExternalTorque.srv

- **Features**

This service returns the torque value generated by the external force on each current joint.

- **Parameters**

Not applicable

- **Return**

Parameter Name	Data Type	Default Value	Description
ext_torque	float64[6]	-	Torque value generated by and external force
success	bool	-	True or False

7.4.16 GetToolForce.srv

▪ Features

This service returns the external force applied to the current tool based on the ref coordinate.

▪ Parameters

Parameter Name	Data Type	Default Value	Description
ref	Int8	0	<ul style="list-style-type: none">• MOVE_REFERENCE_BASE =0• MOVE_REFERENCE_WORLD=2

Note

- **The MOVE_REFERENCE_WORLD argument of ref is only available in M2.40 or later versions.**

▪ Return

Return Name	Data Type	Default Value	Description
tool_force	float64[6]	-	External force applied to the tool
success	bool	-	True or False

7.4.17 GetSolutionSpace.srv

- **Features**

This service obtains the solution space value.

- **Parameters**

Parameter Name	Data Type	Default Value	Description
pos	float64[6]	-	position list

- **Return**

Parameter Name	Data Type	Default Value	Description
sol_space	int8	-	solution space : 0 ~ 7
success	bool	-	True or False

7.4.18 GetOrientationError.srv

▪ Features

This service returns the orientation error value between the arbitrary poses xd and xc of the axis.

▪ Parameters

Parameter Name	Data Type	Default Value	Description
xd	float64[6]	-	position list
xc	float64[6]	-	Position list
axis	int8	-	axis • TASK_AXIS_X : 0 • TASK_AXIS_Y : 1 • TASK_AXIS_Z : 2

▪ Return

Parameter Name	Data Type	Default Value	Description
ori_error	float32	-	Orientaion error value
success	bool	-	True or False

7.5 Service/tcp

7.5.1 ConfigCreateTcp.srv

▪ Features

This service calls creating the name of the TCP information.

▪ Parameters

Parameter Name	Data Type	Default Value	Description
name	string	-	Name of the TCP
pos	float64[6]	-	TCP infomation

▪ Return

Return Name	Data Type	Default Value	Description
success	bool	-	True or False

7.5.2 ConfigDeleteTcp.srv

▪ Features

This service calls deleting the registered TCP information.

▪ Parameters

Parameter Name	Data Type	Default Value	Description
name	string	-	Name of the TCP

▪ Return

Return Name	Data Type	Default Value	Description
success	bool	-	True or False

7.5.3 GetCurrentTcp.srv

- **Features**

It is a service that fetches the currently set TCP information from the robot controller.

- **Parameters**

Parameter Name	Data Type	Default Value	Description
None	-	-	-

- **Return**

Return Name	Data Type	Default Value	Description
info	string	-	Name of the TCP
success	bool	-	True or False

7.5.4 SetCurrentTcp.srv

▪ Features

It is a service to set the information about the currently set the TCP information

▪ Parameters

Parameter Name	Data Type	Default Value	Description
name	string	-	Name of the TCP

▪ Return

Return Name	Data Type	Default Value	Description
success	bool	-	True or False

7.6 Service/tool

7.6.1 ConfigCreateTool.srv

▪ Features

It is a service to register tool information to be mounted on the robot end.

▪ Parameters

Parameter Name	Data Type	Default Value	Description
name	string	-	Name of the TCP
weight	float		Weight of tool
cog	float64[3]		center of mass
inertia	float64[6]		inertia information

▪ Return

Return Name	Data Type	Default Value	Description
success	bool	-	True or False



7.6.2 ConfigDeleteTool.srv

▪ Features

This service calls deleting the registered TOOL information.

▪ Parameters

Parameter Name	Data Type	Default Value	Description
name	string	-	Name of the TCP

▪ Return

Return Name	Data Type	Default Value	Description
success	bool	-	True or False

7.6.3 GetCurrentTool.srv

- **Features**

It is a service that fetches the currently set TOOL information from the robot controller.

- **Parameters**

Parameter Name	Data Type	Default Value	Description
None	-	-	-

- **Return**

Return Name	Data Type	Default Value	Description
info	string	-	Name of the TOOL
success	bool	-	True or False

7.6.4 SetCurrentTool.srv

- **Features**

It is a service to set the information about the currently set the TOOL information

- **Parameters**

Parameter Name	Data Type	Default Value	Description
name	string	-	Name of the TOOL

- **Return**

Return Name	Data Type	Default Value	Description
success	bool	-	True or False

7.6.5 SetToolShape.srv

- **Features**

This service is only available for M2.40 or later versions.

This function activates the tool shape information of the entered name among the tool shape information registered in the Teach Pendant.

- **Parameters**

Parameter Name	Data Type	Default Value	Description
name	string	-	Name of the TOOL

- **Return**

Return Name	Data Type	Default Value	Description
success	bool	-	True or False

7.7 Service/force

7.7.1 ParallelAxis1.srv

▪ Features

This service matches the normal vector of the plane consists of points(x1, x2, x3) based on the ref coordinate(refer to get_normal(x1, x2, x3)) and the designated axis of the tool frame. The current position is maintained as the TCP position of the robot.

▪ Parameters

Parameter Name	Data Type	Default Value	Description
x1	float64[6]	-	position list
x2	float64[6]	-	position list
x3	float64[6]	-	position list
axis	int8	-	<ul style="list-style-type: none"> • TASK_AXIS_X = 0 • TASK_AXIS_Y = 1 • TASK_AXIS_Z = 2
ref	int8	0	<ul style="list-style-type: none"> • MOVE_REFERENCE_BASE =0 • MOVE_REFERENCE_WORLD=2 • MOVE_REFERENCE_USER=101~120

Note

- **The MOVE_REFERENCE_WORLD argument of ref is only available in M2.40 or later versions.**

▪ Return

Parameter Name	Data Type	Default Value	Description
success	bool	-	True or False



7.7.2 ParallelAxis2.srv

▪ Features

This service matches the given vect direction based on the ref coordinate and the designated axis of the tool frame. The current position is maintained as the TCP position of the robot.

▪ Parameters

Parameter Name	Data Type	Default Value	Description
vect	float64[3]	-	vector
axis	int8	-	<ul style="list-style-type: none"> • TASK_AXIS_X = 0 • TASK_AXIS_Y = 1 • TASK_AXIS_Z = 2
ref	int8	0	<ul style="list-style-type: none"> • MOVE_REFERENCE_BASE =0 • MOVE_REFERENCE_WORLD=2 • MOVE_REFERENCE_USER=101~120

Note

- **The MOVE_REFERENCE_WORLD argument of ref is only available in M2.40 or later versions.**

▪ Return

Parameter Name	Data Type	Default Value	Description
success	bool	-	True or False

7.7.3 AlignAxis1.srv

▪ Features

This service matches the normal vector of the plane consists of points(x1, x2, x3) based on the ref coordinate(refer to get_normal(x1, x2, x3)) and the designated axis of the tool frame. The robot TCP moves to the pos position.

▪ Parameters

Parameter Name	Data Type	Default Value	Description
x1	float64[6]	-	position list
x2	float64[6]	-	position list
x3	float64[6]	-	position list
pos	float64[6]	-	position list
axis	int8	-	<ul style="list-style-type: none"> • TASK_AXIS_X = 0 • TASK_AXIS_Y = 1 • TASK_AXIS_Z = 2
ref	int8	0	<ul style="list-style-type: none"> • MOVE_REFERENCE_BASE =0 • MOVE_REFERENCE_WORLD=2 • MOVE_REFERENCE_USER=101~120

Note

- **The MOVE_REFERENCE_WORLD argument of ref is only available in M2.40 or later versions.**

▪ Return

Parameter Name	Data Type	Default Value	Description
success	bool	-	True or False

7.7.4 AlignAxis2.srv

▪ Features

This service matches the given vect direction based on the ref coordinate and the designated axis of the tool frame. The robot TCP moves to the pos position.

▪ Parameters

Parameter Name	Data Type	Default Value	Description
vect	float64[3]	-	vector
pos	float64[6]	-	6개의 Task Space 정보
axis	int	-	<ul style="list-style-type: none"> • TASK_AXIS_X = 0 • TASK_AXIS_Y = 1 • TASK_AXIS_Z = 2
ref	int	0	<ul style="list-style-type: none"> • MOVE_REFERENCE_BASE =0 • MOVE_REFERENCE_WORLD=2 • MOVE_REFERENCE_USER=101~120

Note

- **The MOVE_REFERENCE_WORLD argument of ref is only available in M2.40 or later versions.**

▪ Return

Parameter Name	Data Type	Default Value	Description
success	bool	-	True or False

7.7.5 IsDoneBoltTightening.srv

▪ Features

This service monitors the tightening torque of the tool and returns True if the set torque (m) is reached within the given time and False if the given time has passed.

▪ Parameters

Parameter Name	Data Type	Default Value	Description
m	float64	0	Target torque
timeout	float64	0	Monitoring duration [sec]
axis	int8	-	<ul style="list-style-type: none">• TASK_AXIS_X = 0• TASK_AXIS_Y = 1• TASK_AXIS_Z = 2

▪ Return

Parameter Name	Data Type	Default Value	Description
success	bool	-	True or False



7.7.6 ReleaseComplianceCtrl.srv

- **Features**

This service terminates compliance control and begins position control at the current position.

- **Parameters**

Not applicable

- **Return**

Parameter Name	Data Type	Default Value	Description
success	bool	-	True or False

7.7.7 TaskComplianceCtrl.srv

▪ Features

This service begins task compliance control based on the preset reference coordinate system.

▪ Parameters(Stiffness TBD)

Parameter Name	Data Type	Default Value	Description
stx	float64[6]	[3000, 3000, 3000, 200, 200, 200]	Three translational stiffnesses Three rotational stiffnesses
ref	int8	1	<ul style="list-style-type: none"> • MOVE_REFERENCE_BASE =0 • MOVE_REFERENCE_TOOL=1 • MOVE_REFERENCE_WORLD=2 MOVE_REFERENCE_USER=101~120
time	float	0	Stiffness varying time [sec] Range: 0 - 1.0 * Linear transition during the specified time

▪ Return

Parameter Name	Data Type	Default Value	Description
success	bool	-	True or False

7.7.8 SetStiffnessx.srv

▪ Features

This service sets the stiffness value based on the global coordinate(refer to set_ref_coord()). The linear transition from the current or default stiffness is performed during the time given as STX. The user-defined ranges of the translational stiffness and rotational stiffness are 0-20000N/m and 0-400Nm/rad, respectively.

▪ Parameters

Parameter Name	Data Type	Default Value	Description
stx	float64[6]	[500, 500, 500, 100, 100, 100]	Three translational stiffnesses Three rotational stiffnesses
ref	int8	1	<ul style="list-style-type: none"> • MOVE_REFERENCE_BASE =0 • MOVE_REFERENCE_TOOL=1 • MOVE_REFERENCE_WORLD=2 MOVE_REFERENCE_USER=101~120
time	float	0	Stiffness varying time [sec] Range: 0 - 1.0 * Linear transition during the specified time

▪ Return

Parameter Name	Data Type	Default Value	Description
success	bool	-	True or False

7.7.9 CalcCoord.srv

▪ Features

This service is only available for M2.50 or later versions.

This service returns a new user cartesian coordinate system by using up to 4 input poses ($[x1] \sim [x4]$), input mode [mod] and the reference coordinate system [ref]. The input mode is only valid when the number of input robot poses is 2.

In the case that the number of input poses is 1, the coordinate system is calculated using the position and orientation of $x1$.

In the case that the number of input poses is 2 and the input mode is 0, X-axis is defined by the direction from $x1$ to $x2$, and Z-axis is defined by the projection of the current Tool-Z direction onto the plane orthogonal to the x-axis. The origin is the position of $x1$.

In the case that the number of input poses is 2 and the input mode is 1, X-axis is defined by the direction from $x1$ to $x2$, and Z-axis is defined by the projection of the z direction of $x1$ onto the plane orthogonal to the X-axis. The origin is the position of $x1$.

In the case that the number of input poses is 3, X-axis is defined by the direction from $x1$ to $x2$. If a vector v is the direction from $x1$ to $x3$, Z-axis is defined by the cross product of X-axis and v (X-axis cross v). The origin is the position of $x1$.

In the case that the number of input poses is 4, the definition of axes is identical to the case that the number of input poses is 3, but the origin is the position of $x4$.

▪ Parameters

Parameter Name	Data Type	Default Value	Description
<code>input_pos_cnt</code>	int8		Number of input positions
<code>x1</code>	float64[6]	-	position list
<code>x2</code>	float64[6]	-	position list
<code>x3</code>	float64[6]	-	position list
<code>x4</code>	float64[6]	-	position list

Parameter Name	Data Type	Default Value	Description
ref	int8	-	<ul style="list-style-type: none"> • MOVE_REFERENCE_BASE =0 • MOVE_REFERENCE_WORLD=2
mod	int8	-	input mode (only valid when the number of input poses is 2) <ul style="list-style-type: none"> • 0: defining z-axis based on the current Tool-z direction • 1: defining z-axis based on the z direction of x1

▪ **Return**

Parameter Name	Data Type	Default Value	Description
conv_posx	float64[6]	-	position list
success	bool	-	True or False

7.7.10 SetUserCartCoord1.srv

▪ Features

This service set a new user cartesian coordinate system using input pose [pos] and reference coordinate system[ref]. Up to 20 user coordinate systems can be set including the coordinate systems set within Workcell Item. Since the coordinate system set by this function is removed when the program is terminated, setting new coordinate systems within Workcell Item is recommended for maintaining the coordinate information.

▪ Parameters

Parameter Name	Data Type	Default Value	Description
pos	float64[6]	-	coordinate information (position and orientation)
Ref	int8	-	reference coordinate <ul style="list-style-type: none"> • DR_BASE: base coordinate • DR_WORLD: world coordinate

Note

- **The ref argument is only available in M2.40 or later versions.**

▪ Return

Parameter Name	Data Type	Default Value	Description
id	int8	-	user coordinate ID(101~120) or fail(-1)
success	bool	-	True or False

7.7.11 SetUserCartCoord2.srv

▪ Features

The user can set the new rectangular coordinate system using x1, x2, and x3 based on the ref coordinate. Creates a rectangular coordinate system with ux, uy, and uz as the vector for each axis and origin point is the pos based on the ref coordinate assuming that 1)ux is the unit vector of x1x2 and uy is the unit vector of the vector that represents the shortest distance between x1x2 and x3. A maximum of 20 can be used, and the most recent 20 values are used if there are more than 20.

1)Before M2.0.2 software version, ux is the unit vector of x2x1

▪ Parameters

Parameter Name	Data Type	Default Value	Description
x1	float64[6]	-	position list
x2	float64[6]	-	position list
x3	float64[6]	-	position list
pos	float64[6]		position list
ref	int8	0	<ul style="list-style-type: none"> • MOVE_REFERENCE_BASE =0 • MOVE_REFERENCE_WORLD=2

Note

- **The ref argument is only available in M2.40 or later versions.**

▪ Return

Parameter Name	Data Type	Default Value	Description
id	int8	-	user coordinate ID(101~120) or fail(-1)
success	bool	-	True or False

7.7.12 SetUserCartCoord3.srv

▪ Features

The user can set the new rectangular coordinate system using $u1$ and $v1$ based on the ref coordinate. The origin point of the rectangular coordinate system is pos based on the ref coordinate while the x-axis and y-axis bases are given in the vectors $u1$ and $v1$, respectively. Other directions are determined by $u1 \times v1$. If $u1$ and $v1$ are not orthogonal, $v1'$, that is perpendicular to $u1$ on the surface spanned by $u1$ and $v1$, is set as the vector in the y-axis direction.

▪ Parameters

Parameter Name	Data Type	Default Value	Description
$u1$	float64[3]	-	X-axis unit vector
$v1$	float64[3]	-	Y-axis unit vector
pos	float64[6]	-	position list
ref	int8	0	<ul style="list-style-type: none"> • MOVE_REFERENCE_BASE =0 • MOVE_REFERENCE_WORLD=2

Note

- **The ref argument is only available in M2.40 or later versions.**

▪ Return

Parameter Name	Data Type	Default Value	Description
id	int8	-	user coordinate ID(101~120) or fail(-1)
$success$	bool	-	True or False

7.7.13 OverwriteUserCartCoord.srv

▪ Features

This service is only available for M2.50 or later versions.

This service changes the pose and reference coordinate system of the requested user coordinate system [id] with the [pos] and [ref], respectively.

Parameter Name	Data Type	Default Value	Description
id	int8	-	coordinate ID
pos	float64[6]	-	position list
ref	int8	0	<ul style="list-style-type: none">• MOVE_REFERENCE_BASE =0• MOVE_REFERENCE_WORLD=2

▪ Return

Parameter Name	Data Type	Default Value	Description
id	int8	-	user coordinate ID(101~120) or fail(-1)
success	bool	-	True or False

7.7.14 GetUserCartCoord.srv

▪ Features

This service is only available for M2.50 or later versions.

This service returns the pose and reference coordinate system of the requested user coordinate system [id].

▪ Parameters

Parameter Name	Data Type	Default Value	Description
id	int8	-	coordinate ID

▪ Return

Parameter Name	Data Type	Default Value	Description
conv_posx	float64[6]	-	position list
ref	int8	-	<ul style="list-style-type: none">• MOVE_REFERENCE_BASE =0• MOVE_REFERENCE_WORLD=2
success	bool	-	<ul style="list-style-type: none">• True or False

7.7.15 SetDesiredForce.srv

▪ Features

This service defines the target force, direction, translation time, and mode for force control based on the global coordinate.

▪ Parameters

Parameter Name	Data Type	Default Value	Description
Fd	float64[6]	[0, 0, 0, 0, 0, 0]	Three translational target forces Three rotational target moments
dir	int8[6]	[0, 0, 0, 0, 0, 0]	Force control in the corresponding direction if 1 Compliance control in the corresponding direction if 0
ref	int8	1	<ul style="list-style-type: none"> • MOVE_REFERENCE_BASE =0 • MOVE_REFERENCE_TOOL=1 • MOVE_REFERENCE_WORLD=2 • MOVE_REFERENCE_USER=101~120
time	float64	0.0	Transition time of target force to take effect [sec] Range: 0 - 1.0
mod	int8	0	FORCE_MODE_ABSOLUTE(0): Force control with absolute value FORCE_MODE_RELATIVE(1): force control with relative value to initial state (the instance when this function is called)

▪ Return

Parameter Name	Data Type	Default Value	Description
success	bool	-	True or False

7.7.16 ReleaseForce.srv

- **Features**

This service reduces the force control target value to 0 through the time value and returns the task space to adaptive control.

- **Parameters**

Parameter Name	Data Type	Default Value	Description
time	float64	0.0	Time needed to reduce the force Range: 0 - 1.0

- **Return**

Parameter Name	Data Type	Default Value	Description
success	bool	-	True or False

7.7.17 CheckPositionCondition.srv

▪ Features

This service checks the status of the given position. This condition can be repeated with the while or if statement. Axis and pos of input paramets are based on the ref coordinate.Parameters

Parameter Name	Data Type	Default Value	Description
axis	int8	-	<ul style="list-style-type: none"> FORCE_AXIS_X = 0 FORCE_AXIS_Y = 1 FORCE_AXIS_Z = 2
min	float64	0	Minimum value
max	float64	0	Maximum value
ref	int8	1	<ul style="list-style-type: none"> MOVE_REFERENCE_BASE =0 MOVE_REFERENCE_TOOL=1 MOVE_REFERENCE_WORLD=2 MOVE_REFERENCE_USER=101~120
mod	int8	-	<ul style="list-style-type: none"> MOVE_MODE_ABSOLUTE = 0 MOVE_MODE_RELATIVE = 1
pos	float64[6]	-	position list

알아두기

- The absolution position is used if the mod is DR_MV_MOD_ABS.
- The pos position is used if the mod is DR_MV_MOD_REL.
- Pos is meaningful only if the mod is DR_MV_MOD_REL.

▪ Return

Parameter Name	Data Type	Default Value	Description
success	bool	-	True or False

7.7.18 CheckForceCondition.srv

▪ Features

This service checks the status of the given force. It disregards the force direction and only compares the sizes. This condition can be repeated with the while or if statement. Measuring the force, axis is based on the ref coordinate and measuring the moment, axis is based on the tool coordinate.

▪ Parameters

Parameter Name	Data Type	Default Value	Description
axis	int8	-	<ul style="list-style-type: none"> • FORCE_AXIS_X = 0 • FORCE_AXIS_Y = 1 • FORCE_AXIS_Z = 2 • FORCE_AXIS_A = 10 • FORCE_AXIS_B = 11 • FORCE_AXIS_C = 12
min	float64	-	Minimum value (min ≥ 0)
max	float64	-	Maximum value (max ≥ 0)
ref	int8	None	<ul style="list-style-type: none"> • MOVE_REFERENCE_BASE =0 • MOVE_REFERENCE_TOOL=1 • MOVE_REFERENCE_WORLD=2 • MOVE_REFERENCE_USER=101~120

▪ Return

Parameter Name	Data Type	Default Value	Description
success	bool	-	True or False

7.7.19 CheckOrientationCondition1.srv

▪ Features

This service checks the difference between the current pose and the specified pose of the robot end effector. It returns the difference between the current pose and the specified pose in rad with the algorithm that transforms it to a rotation matrix using the “AngleAxis” technique. It returns True if the difference is positive (+) and False if the difference is negative (-). It is used to check if the difference between the current pose and the rotating angle range is + or -. For example, the function can use the direct teaching position to check if the difference from the current position is + or - and then create the condition for the orientation limit. This condition can be repeated with the while or if statement.

- Setting Min only: True if the difference is + and False if -
- Setting Min and Max: True if the difference from min is - while the difference from max is + and False otherwise
- Setting Max only: True if the maximum difference is + and False otherwise

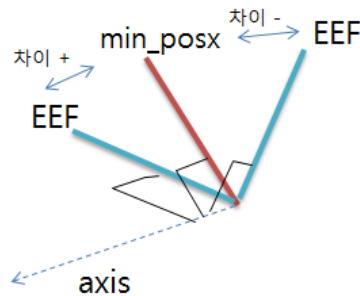

▪ Parameters

Parameter Name	Data Type	Default Value	Description
axis	int8	-	<ul style="list-style-type: none"> • FORCE_AXIS_A = 10 • FORCE_AXIS_B = 11 • FORCE_AXIS_C = 12
min	float64[6]	-	position list
max	float64[6]	-	position list
ref	int8	1	<ul style="list-style-type: none"> • MOVE_REFERENCE_BASE =0

Parameter Name	Data Type	Default Value	Description
			<ul style="list-style-type: none">• MOVE_REFERENCE_TOOL=1• MOVE_REFERENCE_WORLD=2• MOVE_REFERENCE_USER=101~120
mod	int8	0	<ul style="list-style-type: none">• MOVE_MODE_ABSOLUTE = 0• MOVE_MODE_RELATIVE = 1

▪ **Return**

Parameter Name	Data Type	Default Value	Description
success	bool	-	True or False

7.7.20 CheckOrientationCondition2.srv

▪ Features

This service checks the difference between the current pose and the rotating angle range of the robot end effector. It returns the difference (in rad) between the current pose and the rotating angle range with the algorithm that transforms it to a rotation matrix using the “AngleAxis” technique. It returns True if the difference is positive (+) and False if the difference is negative (-). It is used to check if the difference between the current pose and the rotating angle range is + or -. For example, the function can be used to set the rotating angle range to min and max at any reference position, and then determine the orientation limit by checking if the difference from the current position is + or -. This condition can be repeated with the while or if statement.

- Setting Min only: True if the difference is + and False if -
- Setting Min and Max: True if the difference from min is - while the difference from max is + and False if the opposite.
- Setting Max only: True if the maximum difference is + and False otherwise

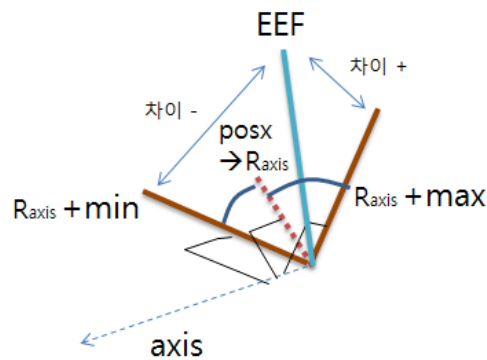

Note

Range of rotating angle: This means the relative angle range (min, max) based on the specified axis from a given position based on the ref coordinate.

▪ Parameters

Parameter Name	Data Type	Default Value	Description
axis	int8	-	<ul style="list-style-type: none"> • FORCE_AXIS_X = 0 • FORCE_AXIS_Y = 1

Parameter Name	Data Type	Default Value	Description
			<ul style="list-style-type: none"> FORCE_AXIS_Z = 2
min	float64	-	Minimum value
max	float64	-	Maximum value
ref	int8	1	<ul style="list-style-type: none"> MOVE_REFERENCE_BASE = 0 MOVE_REFERENCE_TOOL = 1 MOVE_REFERENCE_WORLD = 2 MOVE_REFERENCE_USER = 101~120
mod	int8	0	<ul style="list-style-type: none"> MOVE_MODE_ABSOLUTE = 0 MOVE_MODE_RELATIVE = 1
pos	float64[6]	-	position list

▪ **Return**

Parameter Name	Data Type	Default Value	Description
success	bool	-	True or False

7.7.21 CoordTransform.srv

▪ Features

This service transforms given task position expressed in reference coordinate, ‘ref_in’ to task position expressed in reference coordinate, ‘ref_out’. It returns transformed task position. It supports calculation of coordinate transformation for the following cases.

- (ref_in) world reference coordinate → (ref_out) world reference coordinate
- (ref_in) world reference coordinate → (ref_out) base reference coordinate
- (ref_in) world reference coordinate → (ref_out) tool reference coordinate
- (ref_in) world reference coordinate → (ref_out) user reference coordinate
- (ref_in) base reference coordinate → (ref_out) base reference coordinate
- (ref_in) base reference coordinate → (ref_out) tool reference coordinate
- (ref_in) base reference coordinate → (ref_out) user reference coordinate
- (ref_in) tool reference coordinate → (ref_out) world reference coordinate
- (ref_in) tool reference coordinate → (ref_out) base reference coordinate
- (ref_in) tool reference coordinate → (ref_out) tool reference coordinate
- (ref_in) tool reference coordinate → (ref_out) user reference coordinate
- (ref_in) user reference coordinate → (ref_out) world reference coordinate
- (ref_in) user reference coordinate → (ref_out) base reference coordinate
- (ref_in) user reference coordinate → (ref_out) tool reference coordinate
- (ref_in) user reference coordinate → (ref_out) user reference coordinate

Parameters

Parameter Name	Data Type	Default Value	Description
pose_in	float64[6]	-	position list
ref_in	int8	DR_COND_NONE	<ul style="list-style-type: none"> • MOVE_REFERENCE_BASE =0 • MOVE_REFERENCE_TOOL=1 • MOVE_REFERENCE_WORLD=2 • MOVE_REFERENCE_USER=101~120
ref_out	int8	DR_COND_NONE	<ul style="list-style-type: none"> • MOVE_REFERENCE_BASE =0

Parameter Name	Data Type	Default Value	Description
			<ul style="list-style-type: none">• MOVE_REFERENCE_TOOL=1• MOVE_REFERENCE_WORLD=2• MOVE_REFERENCE_USER=101~120

▪ **Return**

Parameter Name	Data Type	Default Value	Description
conv_posx	float64[6]	-	position list
success	bool	-	True or False



7.7.22 GetWorkpieceWeight.srv

- **Features**

This service measures and returns the weight of the workpiece.

- **Parameters**

Not applicable

- **Return**

Parameter Name	Data Type	Default Value	Description
weight	float64	-	positive value : measured weight negative value : error
success	bool	-	True or False

7.7.23 ResetWorkppieceWeight.srv

- **Features**

This service matches the normal vector of the plane consists of points(x1, x2, x3) based on the ref coordinate(refer to get_normal(x1, x2, x3)) and the designated axis of the tool frame. The current position is maintained as the TCP position of the robot.

- **Parameters**

None

- **Return**

Parameter Name	Data Type	Default Value	Description
success	bool	-	True or False



7.8 Service/io

7.8.1 SetCtlBoxDigitalOutput.srv

▪ Features

This service sends a signal at the digital contact point of the controller..

▪ Parameters

Parameter Name	Data Type	Default Value	Description
index	int8	-	I/O contact number mounted on the controller <ul style="list-style-type: none">• Val argument existing: A number between 1 and 16
value	int8		I/O value <ul style="list-style-type: none">• ON: 1• OFF: 0

▪ Return

Return Name	Data Type	Default Value	Description
success	bool	-	True or False

7.8.2 GetCtlBoxDigitalOutput.srv

▪ Features

This service reads the current digital io output status .

▪ Parameters

Parameter Name	Data Type	Default Value	Description
index	int8	-	A number 1 - 16 which means the contact number of I/O mounted on the controller.

▪ Return

Return Name	Data Type	Default Value	Description
value	int8	-	current status (OFF =0, ON =1)
success	bool	-	True or False

7.8.3 GetCtlBoxDigitalInput.srv

- **Features**

This service reads the signals from digital contact points of the controller.

- **Parameters**

Parameter Name	Data Type	Default Value	Description
index	int8	-	A number 1 - 16 which means the contact number of I/O mounted on the controller.

- **Return**

Return Name	Data Type	Default Value	Description
value	int8	-	OFF =0, ON =1
success	bool	-	True or False

7.8.4 SetToolDigitalOutput.srv

▪ Features

This service sends the signal of the robot tool from the digital contact point.

▪ Parameters

Parameter Name	Data Type	Default Value	Description
index	int8	-	I/O contact number mounted on the robot arm <ul style="list-style-type: none">Val argument existing: A number between 1 and 6
value	int8	-	I/O value <ul style="list-style-type: none">ON: 1OFF: 0

▪ Return

Return Name	Data Type	Default Value	Description
success	bool	-	True or False

7.8.5 GetToolDigitalOutput.srv

▪ Features

This service reads the current tool digital io output status.

▪ Parameters

Parameter Name	Data Type	Default Value	Description
index	int8	-	I/O contact number (1-6) mounted on the robot tool

▪ Return

Return Name	Data Type	Default Value	Description
value	int8	-	current status (OFF =0, ON =1)
success	bool	-	True or False

7.8.6 GetToolDigitalInput.srv

▪ Features

This service reads the signal of the robot tool from the digital contact point.

▪ Parameters

Parameter Name	Data Type	Default Value	Description
index	int8	-	I/O contact number (1-6) mounted on the robot tool

▪ Return

Return Name	Data Type	Default Value	Description
value	int8	-	OFF =0, ON =1
success	bool	-	True or False

7.8.7 SetCtlBoxAnalogOutputType.srv

▪ Features

This service sets the channel mode of the controller analog output..

▪ Parameters

Parameter Name	Data Type	Default Value	Description
channel	int8	-	<ul style="list-style-type: none">• 1 : channel 1• 2 : channel 2
mode	int8	-	analog io mode <ul style="list-style-type: none">• current =0• voltage =1

▪ Return

Return Name	Data Type	Default Value	Description
success	bool	-	True or False

7.8.8 SetCtlBoxAnalogInputType.srv

▪ Features

This service sets the channel mode of the controller analog input.

▪ Parameters

Parameter Name	Data Type	Default Value	Description
channel	int8	-	<ul style="list-style-type: none">• 1 : channel 1• 2 : channel 2
mode	int8	-	analog io mode <ul style="list-style-type: none">• current =0• voltage =1

▪ Return

Return Name	Data Type	Default Value	Description
success	bool	-	True or False



7.8.9 SetCtlBoxAnalogOutput.srv

▪ Features

This service outputs the channel value corresponding to the controller analog output.

▪ Parameters

Parameter Name	Data Type	Default Value	Description
channel	int8	-	<ul style="list-style-type: none">1 : channel 12 : channel 2
value	float64	-	analog output value <ul style="list-style-type: none">Current mode: 4.0~20.0 [mA]Voltage mode: 0~10.0 [V]

▪ Return

Return Name	Data Type	Default Value	Description
success	bool	-	True or False

7.8.10 GetCtlBoxAnalogInput.srv

▪ Features

This service reads the channel value corresponding to the controller analog input.

▪ Parameters

Parameter Name	Data Type	Default Value	Description
channel	int8	-	<ul style="list-style-type: none">• 1 : channel 1• 2 : channel 2

▪ Return

Return Name	Data Type	Default Value	Description
value	float	-	The analog input value of the specified channel <ul style="list-style-type: none">• Current mode: 4.0~20.0 [mA]• Voltage mode: 0~10.0 [V]
success	bool	-	True or False

7.9 Service/modbus

7.9.1 ConfigCreateModbus.srv

▪ Features

This service registers the Modbus signal. The Modbus I/O must be set in the Teach Pendant I/O set-up menu. Use this command only for testing if it is difficult to use the Teach Pendant. The Modbus menu is disabled in the Teach Pendant if it is set using this command.

▪ Parameters

Parameter Name	Data Type	Default Value	Description
name	string	-	Modbus signal name
ip	string	-	IP address of the Modbus module
port	int8	-	Port number of the Modbus module
reg_type	int8	-	Modbus signal type <ul style="list-style-type: none"> • MODBUS_REGISTER_TYPE_DISCRETE_INPUTS • MODBUS_REGISTER_TYPE_COILS • MODBUS_REGISTER_TYPE_INPUT_REGISTER • MODBUS_REGISTER_TYPE_HOLDING_REGISTER
index	int8	-	Modbus signal의 index
value	int8	-	Output when the type is MODBUS_REGISTER_TYPE_COILS or MODBUS_REGISTER_TYPE_HOLDING_REGISTER (ignored otherwise)

- **Return**

Return Name	Data Type	Default Value	Description
success	bool	-	True or False



7.9.2 ConfigDeleteModbus.srv

▪ Features

This service deletes the registered Modbus signal. The Modbus I/O must be set in the Teach Pendant I/O set-up menu. Use this command only for testing if it is difficult to use the Teach Pendant. The Modbus menu is disabled in the Teach Pendant if it is set using this command.

▪ Parameters

Parameter Name	Data Type	Default Value	Description
name	string	-	Name of the registered Modbus signal

▪ Return

Return Name	Data Type	Default Value	Description
success	bool	-	True or False

7.9.3 SetModbusOutput.srv

▪ Features

This service sends the signal to an external Modbus system.

▪ Parameters

Parameter Name	Data Type	Default Value	Description
name	string	-	Modbus name
value	int32	-	Modbus digital I/O <ul style="list-style-type: none">• ON : 1• OFF : 0
			Value for Modbus analog I/O

▪ Return

Return Name	Data Type	Default Value	Description
success	bool	-	True or False

7.9.4 GetModbuInput.srv

- **Features**

This service reads the signal from the Modbus system.

- **Parameters**

Parameter Name	Data Type	Default Value	Description
name	string	-	Modbus name

- **Return**

Return Name	Data Type	Default Value	Description
value	int32	-	ON or Off in the case of the Modbus digital I/O
			The register value in the case of the Modbus analog module
success	bool	-	True or False

7.10 Service/drl

7.10.1 DrlStart.srv

▪ Features

This service is used to execute DRL script. (DRL is a Doosan robot language).



Caution

The drl service is only available in real mode.

▪ Parameters

Parameter Name	Data Type	Default Value	Description
RobotSystem	int8	-	
Code	string	-	DRL code string

▪ Return

Return Name	Data Type	Default Value	Description
success	bool	-	True or False



Note

- Robot operation status should be in STANDBY state (STATE_STANDBY) and should be used when robot mode is in auto mode.
- DRL programming should be done by referring to the Programming Manual.
-

7.10.2 DrlStop.srv

▪ Features

This service is used to stop the DRL program (task) currently running on the robot controller. Stops differently according to the eStopType received as an argument, and stops the motion of the current section



Caution

The drl service is only available in real mode.

▪ Parameters

Parameter Name	Data Type	Default Value	Description
stop_mode	int8	-	drl stop mode <ul style="list-style-type: none"> • STOP_TYPE_QUICK_STO = 0 • STOP_TYPE_QUICK = 1 • STOP_TYPE_SLOW = 2 • STOP_TYPE_HOLD = • STOP_TYPE_EMERGENCY = 3

▪ Return

Return Name	Data Type	Default Value	Description
Success	bool	-	True or False

7.10.3 DrlPause.srv

▪ Features

This is a service to temporarily stop the DRL program (task) currently running on the robot controller.



Caution

The drl service is only available in real mode.

▪ Parameters

Parameter Name	Data Type	Default Value	Description
None	-	-	-

▪ Return

Return Name	Data Type	Default Value	Description
success	bool	-	True or False

7.10.4 DrlResume.srv

▪ Features

This is a service to resume the currently paused DRL program (task) from the robot controller.



Caution

The drl service is only available in real mode.

▪ Parameters

Parameter Name	Data Type	Default Value	Description
None	-	-	-

▪ Return

Return Name	Data Type	Default Value	Description
success	bool	-	True or False

7.10.5 GetDrlState.srv

▪ Features

This service reads the status of the DRL program



Caution

The drl service is only available in real mode.

▪ Parameters

Parameter Name	Data Type	Default Value	Description
None	-	-	-

▪ Return

Return Name	Data Type	Default Value	Description
state	int8	-	state of DRL program . 0 : DRL_PROGRAM_STATE_PLAY . 1 : DRL_PROGRAM_STATE_STOP . 2 : DRL_PROGRAM_STATE_HOLD
success	bool	-	True or False

7.11 Service/gripper

7.11.1 SerialSendData.srv

- **Features**

It controls the gripper through actual serial communication.

- **Parameters**

Parameter Name	Data Type	Default Value	Description
data	string	-	String to send

- **Return**

Return Name	Data Type	Default Value	Description
success	bool	-	True or False

7.11.2 RobotiqMove.srv

- **Features**

It is a service to control robotiq's gripper in simulator environment.

- **Parameters**

Parameter Name	Data Type	Default Value	Description
width	float	-	Width of finger gripper : 0.0(close)~0.8(open)

- **Return**

Return Name	Data Type	Default Value	Description
success	bool	-	True or False



8. Motion-related Functions

8.1 posj(q1=0, q2=0, q3=0, q4=0, q5=0, q6=0)

▪ Features

This function designates the joint space angle in coordinate values.

▪ Parameters

No.	Data Type	Default Value	Description
q1	float list posj	0	1-axis angle or angle list or posj
q2	float	0	2-axis angle
q3	float	0	3-axis angle
q4	float	0	4-axis angle
q5	float	0	5-axis angle
q6	float	0	6-axis angle

▪ Return

posj

▪ Exception

Exception	Description
DR_Error (DR_ERROR_TYPE)	Parameter data type error occurred

▪ Example

```
q1 = posj()           # q1=posj(0,0,0,0,0,0)
q2 = posj(0, 0, 90, 0, 90, 0)
q3 = posj([0, 30, 60, 0, 90, 0]) # q3=posj(0,30,60,0,90,0)
```

▪ Related commands

movej()/amovej()/movesj()/amovesj()

8.2 posx(x=0, y=0, z=0, w=0, p=0, r=0)

▪ Features

This function designates the task space in coordinate values.

▪ Parameters

Parameter Name	Data Type	Default Value	Description
x	float list posx	0	z position or position list or posx
y	float	0	y position
z	float	0	z position
w	float	0	w orientation (z-direction rotation of reference coordinate system)
p	float	0	p orientation (y-direction rotation of w rotated coordinate system)
r	float	0	r orientation (z-direction rotation of w and p rotated coordinate system)

▪ Return

posx

▪ Exception

Exception	Description
DR_Error (DR_ERROR_TYPE)	Parameter data type error occurred

▪ Example

```

movej([0,0,90,0,90,0], v=10, a=20)
x2 = posx(400, 300, 500, 0, 180, 0)
x3 = posx([350, 350, 450, 0, 180, 0])    #x3=posx(350, 350, 450, 0, 180, 0)
x4 = posx(x2)                            #x4=posx(400, 300, 500, 0, 180, 0)
movel(x2, v=100, a=200)
    
```

▪ Related commands

movel()/movec()/movejx()/amovel()/amovec()/amovejx()

8.3 trans(pos, delta, ref, ref_out)

■ Features

- Input parameter(pos) based on the ref coordinate is translated/rotated as delta based on the same coordinate and this function returns the result that is converted to the value based on the ref_out coordinate.
- In case that the ref coordinate is the tool coordinate, this function returns the value based on input parameter(pos)'s coordinate without ref_out coordinate.

■ Parameters

Parameter Name	Data Type	Default Value	Description
pos	posx	-	posx or position list
	list (float[6])		
delta	posx	-	posx or position list
	list (float[6])		
ref	int	None	reference coordinate <ul style="list-style-type: none"> • DR_BASE : base coordinate • DR_WORLD : world coordinate • DR_TOOL : tool coordinate • user coordinate : user defined
ref_out	int	DR_BASE	reference coordinate <ul style="list-style-type: none"> • DR_BASE : base coordinate • DR_WORLD : world coordinate • user coordinate : user defined

Note

- The ref argument DR_WORLD is only available in M2.40 and later versions.
- The ref_out argument is only available in M2.40 and later versions.

Return

Value	Description
posx list (float[6])	task space point



▪ **Exception**

Exception	Description
DR_Error (DR_ERROR_TYPE)	Parameter data type error occurred
DR_Error (DR_ERROR_VALUE)	Parameter value is invalid
DR_Error (DR_ERROR_RUNTIME)	C extension module error occurred
DR_Error (DR_ERROR_STOP)	Program terminated forcefully

▪ **Example**

```
p0 = posj(0,0,90,0,90,0)
movej(p0, v=30, a=30)

x1 = posx(200, 200, 200, 0, 180, 0)
delta = [100, 100, 100, 0, 0, 0]
x2 = trans(x1, delta, DR_BASE, DR_BASE)

x1_base = posx(500, 45, 700, 0, 180, 0)
x4 = trans(x1_base, [10, 0, 0, 0, 0, 0], DR_TOOL)
movel(x4, v=100, a=100, ref=DR_BASE)

uu1 = [1, 1, 0]
vv1 = [-1, 1, 0]
pos = posx(559, 34.5, 651.5, 0, 180.0, 0)
DR_userTC1 = set_user_cart_coord(uu1, vv1, pos) #user defined coordinate system
x1_userTC1 = posx(30, 20, 100, 0, 180, 0) #posx on user coordinate system
x9 = trans(x1_userTC1, [0, 0, 50, 0, 0, 0], DR_userTC1, DR_BASE)
movel(x9, v=100, a=100, ref=DR_BASE)
```

▪ **Related commands**

posx()/addto()

8.4 posb(seg_type, posx1, posx2=None, radius=0)

▪ Features

- Input parameters for constant-velocity blending motion (moveb and amoveb) with the Posb coordinates of each waypoint and the data of the unit path type (line or arc) define the unit segment object of the trajectory to be blended.
- Only posx1 is inputted if seg_type is a line (DR_LINE), and posx2 is also inputted if seg_type is a circle (DR_CIRCLE). Radius sets the blending radius with the continued segment.

▪ Parameters

Parameter Name	Data Type	Default Value	Description
seg_type	Int	-	DR_LINE DR_CIRCLE
posx1	posx	-	1 st task posx
posx2	posx	-	2 nd task posx
radius	float	0	Blending radius [mm]

▪ Return

posb

▪ Exception

Exception	Description
DR_Error (DR_ERROR_TYPE)	Parameter data type error occurred

▪ Example

```

q0 = posj(0, 0, 90, 0, 90, 0)
movej(q0, vel=30, acc=60)
x0 = posx(564, 34, 690, 0, 180, 0)
movej(x0, vel=200, acc=400)    # Moves to the start position.

x1 = posx(564, 200, 690, 0, 180, 0)
seg1 = posb(DR_LINE, x1, radius=40)
x2 = posx(564, 100, 590, 0, 180, 0)
x2c = posx(564, 200, 490, 0, 180, 0)
seg2 = posb(DR_CIRCLE, x2, x2c, radius=40)
x3 = posx(564, 300, 490, 0, 180, 0)
    
```



```
seg3 = posb(DR_LINE, x3, radius=40)
x4 = posx(564, 400, 590, 0, 180, 0)
x4c = posx(564, 300, 690, 0, 180, 0)
seg4 = posb(DR_CIRCLE, x4, x4c, radius=40)
x5 = posx(664, 300, 690, 0, 180, 0)
seg5 = posb(DR_LINE, x5, radius=40)
x6 = posx(564, 400, 690, 0, 180, 0)
x6c = posx(664, 500, 690, 0, 180, 0)
seg6 = posb(DR_CIRCLE, x6, x6c, radius=40)
x7 = posx(664, 400, 690, 0, 180, 0)
seg7 = posb(DR_LINE, x7, radius=40)
x8 = posx(664, 400, 590, 0, 180, 0)
x8c = posx(564, 400, 490, 0, 180, 0)
seg8 = posb(DR_CIRCLE, x8, x8c, radius=0)      # The last radius must be 0.
      # If not 0, it is processed as 0.

b_list = [seg1, seg2, seg3, seg4, seg5, seg6, seg7, seg8]

moveb(b_list, vel=200, acc=400)
```

- **Related commands**

posx()/moveb()/amoveb()

8.5 fkin(pos, ref)

Features

This function receives the input data of joint angles or equivalent forms (float[6]) in the joint space and returns the TCP (objects in the task space) based on the ref coordinate.

Parameters

Parameter Name	Data Type	Default Value	Description
pos	posj	-	posj or
	list (float[6])		position list
ref	int	DR_BASE	reference coordinate • DR_BASE : base coordinate • DR_WORLD : world coordinate

Note

- The ref argument is only available in M2.40 or later versions.

Return

Value	Description
posx	Task space point

Exception

Exception	Description
DR_Error (DR_ERROR_TYPE)	Parameter data type error occurred
DR_Error (DR_ERROR_VALUE)	Parameter value is invalid
DR_Error (DR_ERROR_RUNTIME)	C extension module error occurred

Example

```

q1 = posj(0, 0, 90, 0, 90, 0)
movej(q1,v=10,a=20)
q2 = posj(30, 0, 90, 0, 90, 0)
x2 = fkin(q2, DR_WORLD)
# x2: Space coordinate at the edge of the robot (TCP) corresponding to joint value q2
moveL(x2,v=100,a=200,ref=DR_WORLD) # Linear motion to x2
    
```



- **Related commands**

set_tcp() # The tcp data of the name registered in the teach pendant (TP) is reflected during an fkin operation.
posj()/posx()

8.6 ikin(pos, sol_space, ref)

Features

This function returns the joint position corresponding to sol_space, which is equivalent to the robot pose in the operating space, among 8 joint shapes.

Parameters

Parameter Name	Data Type	Default Value	Description
pos	posx	-	posx or position list
	list (float[6])		
sol_space	int	-	solution space
ref	int	DR_BASE	reference coordinate <ul style="list-style-type: none"> DR_BASE : base coordinate DR_WORLD : world coordinate

Note

- The ref argument is only available in M2.40 or later versions.

Robot configuration vs. solution space

Solution space	Binary	Shoulder	Elbow	Wrist
0	000	Lefty	Below	No Flip
1	001	Lefty	Below	Flip
2	010	Lefty	Above	No Flip
3	011	Lefty	Above	Flip
4	100	Righty	Below	No Flip
5	101	Righty	Below	Flip
6	110	Righty	Above	No Flip

Return

Value	Description
posj	Joint space point

- **Exception**

Exception	Description
DR_Error (DR_ERROR_TYPE)	Parameter data type error occurred
DR_Error (DR_ERROR_VALUE)	Parameter value is invalid
DR_Error (DR_ERROR_RUNTIME)	C extension module error occurred
DR_Error (DR_ERROR_STOP)	Program terminated forcefully

- **Example**

```
x1 = posx(370.9, 719.7, 651.5, 90, -180, 0)
q1 = ikin(x1, 2) # Joint angle q1 where the coordinate of the robot edge is x1 (second
of 8 cases)
# q1=posj(60.3, 81.0, -60.4, -0.0, 159.4, -29.7) (M1013, tcp=(0,0,0))
movej(q1,v=10,a=20)
```

- **Related commands**

set_tcp()/posj()/posx()

8.7 set_velj(vel)

▪ Features

This function sets the global velocity in joint motion (movej, movejx, amovej, or amovejx) after using this command. The default velocity is applied to the globally set vel if movej() is called without the explicit input of the velocity argument.

▪ Parameters

Parameter Name	Data Type	Default Value	Description
vel	float	-	velocity (same to all axes) or
	list (float[6])		velocity (to an axis)

▪ Return

Value	Description
0	Success

▪ Exception

Exception	Description
DR_Error (DR_ERROR_TYPE)	Parameter data type error occurred

▪ Example

```
#1
Q1 = posj(0,0,90,0,90,0)
Q2 = posj(0,0,0,0,90,0)
movej(Q1, vel=10, acc=20)
set_velj(30)      # The global joint velocity is set to 30 (deg/sec).
set_accj(60)     # The global joint acceleration is set to 60 (deg/sec2). [See set_accj().]
movej(Q2)        # The joint motion velocity to Q2 is 30 (deg/sec) which is the global velocity.
movej(Q1, vel=20, acc=40) # The joint motion velocity to Q1 is 20 (deg/sec) which is the specified
velocity.
#2
set_velj(20.5)   # Decimal point input is possible.
set_velj([10, 10, 20, 20, 30, 10]) # The global velocity can be specified to each axis.
```

▪ Related commands

set_accx()/movej()/movejx()/movesj()/amovej()/amovejx()/movesj()

8.8 set_accj(acc)

Features

This function sets the global velocity in joint motion (movej, movejx, amovej, or amovejx) after using this command. The globally set acceleration is applied as the default acceleration if movej() is called without the explicit input of the acceleration argument.

Parameters

Parameter Name	Data Type	Default Value	Description
acc	float	-	acceleration (same to all axes) or
	list (float[6])		acceleration (acceleration to an axis)

Return

Value	Description
0	Success

Exception

Exception	Description
DR_Error (DR_ERROR_TYPE)	Parameter data type error occurred

Example

```
#1
Q1 = posj(0,0,90,0,90,0)
Q2 = posj(0,0,0,0,90,0)
movej(Q1, vel=10, acc=20)
set_velj(30) # The global joint velocity is set to 30 (deg/sec). [See set_velj().]
set_accj(60) # The global joint acceleration is set to 60 (deg/sec2).
movej(Q2) # The joint motion acceleration to Q2 is 60(deg/sec2) which is the global acceleration.
movej(Q1, vel=20, acc=40) # The joint motion acceleration to Q1 is 40(deg/sec2) which is the specified
acceleration.
#2
set_accj(30.55)
set_accj([30, 40, 30, 30, 30, 10])
```

Related commands

set_velj()/movej()/movejx()/movesj()/amovej()/amovejx()/movesj()

8.9 set_velx(vel1, vel2)

Features

This function sets the velocity of the task space motion globally. The globally set velocity velx is applied as the default velocity if the task motion such as movej(), amovej(), movec(), movesx() is called without the explicit input of the velocity value. In the set value, vel1 and vel2 define the linear velocity and rotating velocity, relatively, of TCP.

Parameters

Parameter Name	Data Type	Default Value	Description
vel1	float	-	velocity 1
vel2	float	-	velocity 2

Return

Value	Description
0	Success

Exception

Exception	Description
DR_Error (DR_ERROR_TYPE)	Parameter data type error occurred

Example

```

<#1>
P0 = posj(0,0,90,0,90,0)
movej(P0)
P1 = posx(400,500,800,0,180,0)
P2 = posx(400,500,500,0,180,0)
movej(P1, vel=10, acc=20)
set_velx(30,20) # The global task velocity is set to 30(mm/sec) and 20(deg/sec).
set_accx(60,40) # The global task acceleration is set to 60(mm/sec2) and
40(deg/sec2).
movej(P2) # The task motion velocity to P2 is 30(mm/sec) and
20(deg/sec) which are the global velocity.
movej(P1, vel=20, acc=40) # The task motion velocity to P1 is 20(mm/sec) and
20(deg/sec) which are the specified velocity.
<#2>
set_velx(10.5, 19.4) # Decimal point input is possible.
    
```

Related commands

set_accx()/movej()/movec()/movesx()/moveb()/move_spiral()/amovej()/amovec()/
amovesx()/amoveb()/amove_spiral()

8.10 set_velx(vel)

▪ Features

This function sets the linear velocity of the task space motion globally. The globally set velocity `vel` is applied as the default velocity if the task motion such as `movej()`, `amovej()`, `movec()`, `movesx()` is called without the explicit input of the velocity value. The set value `vel` defines the linear velocity of the TCP while the rotating velocity of the TCP is determined proportionally to the linear velocity.

▪ Parameters

Parameter Name	Data Type	Default Value	Description
<code>vel</code>	float	-	velocity

▪ Return

Value	Description
0	Success

▪ Exception

Exception	Description
<code>DR_Error (DR_ERROR_TYPE)</code>	Parameter data type error occurred

▪ Example

```
#1
p0 = posj(0,0,90,0,90,0)
movej(p0)

P1 = posx(400,500,800,0,180,0)
P2 = posx(400,500,500,0,180,0)
movej(P1, vel=10, acc=20)
set_velx(30) # The global task velocity is set to 30 (mm/sec). The global task angular
velocity is automatically determined.
set_accx(60) # The global task acceleration is set to 60 (mm/sec2). The global task
angular acceleration is automatically determined.
movej(P2) # The task motion linear velocity to P2 is 30(mm/sec) which is the global
velocity.
movej(P1, vel=20, acc=40) # The task motion linear velocity to P1 is 20(mm/sec)
which is the specified velocity.
#2
set_velx(10.5) # Decimal point input is possible.
```

▪ Related commands

`set_accx()/movej()/movec()/movesx()/moveb()/move_spiral()/amovej()/amovec()/`
`amovesx()/amoveb()/amove_spiral()`

8.11 set_accx(acc1, acc2)

Features

This function sets the acceleration of the task space motion globally. The globally set acceleration accx is applied as the default acceleration if the task motion such as `movej()`, `amovel()`, `movec()`, `movesx()` is called without the explicit input of the acceleration value. In the set value, acc1 and acc2 define the linear acceleration and rotating acceleration, relatively, of the TCP.

Parameters

Parameter Name	Data Type	Default Value	Description
acc1	float	-	acceleration 1
acc2	float	-	acceleration 2

Return

Value	Description
0	Success

Exception

Exception	Description
DR_Error (DR_ERROR_TYPE)	Parameter data type error occurred

Example

```
P0 = posj(0,0,90,0,90,0)
movej(P0)
P1 = posx(400,500,800,0,180,0)
P2 = posx(400,500,500,0,180,0)
movej(P1, vel=10, acc=20)
set_velx(30,20) # The global task velocity is set to 30(mm/sec) and 20(deg/sec).
set_accx(60,40) # The global task acceleration is set to 60(mm/sec2) and
40(deg/sec2).
movej(P2) # The task motion acceleration to P2 is 60(mm/sec2) and 40(deg/sec2)
which is the global acceleration.
movej(P1, vel=20, acc=40) # The task motion acceleration to P1 is 40(mm/sec)
and 40(deg/sec2) which is the specified acceleration.
```

Related commands

`set_velx()/movej()/movec()/movesx()/moveb()/move_spiral()/amovel()/amovec()/amove
sx()/amoveb()/amove_spiral()`



8.12 set_accx(acc)

▪ Features

This function sets the linear acceleration of the task space motion globally. The globally set acceleration `acc` is applied as the default acceleration if the task motion such as `movej()`, `amovel()`, `movec()`, `movesx()` is called without the explicit input of the acceleration value. The set value `acc` defines the linear acceleration of the TCP while the rotating acceleration of the TCP is determined proportionally to the linear acceleration.

▪ Parameters

Parameter Name	Data Type	Default Value	Description
<code>acc</code>	float	-	acceleration

▪ Return

Value	Description
0	Success

▪ Exception

Exception	Description
<code>DR_Error (DR_ERROR_TYPE)</code>	Parameter data type error occurred

▪ Example

```
P0 = posj(0,0,90,0,90,0)
movej(P0)
P1 = posx(400,500,800,0,180,0)
P2 = posx(400,500,500,0,180,0)
movej(P0, vel=10, acc=20)
movel(P1, vel=10, acc=20)
set_velx(30)      # The global task velocity is set to 30 (mm/sec). The global task angular velocity is
                  # automatically determined.
set_accx(60)     # The global task acceleration is set to 60 (mm/sec2). The global task angular acceleration
                  # is automatically determined.
movel(P2)        # The task motion linear acceleration to P2 is 60(mm/sec2) which is the global
                  # acceleration.
movel(P1, vel=20, acc=40) # The task motion linear acceleration to P1 is 40(mm/sec2) which is the
                  # specified acceleration.
```

▪ Related commands

`set_velx()/movel()/movec()/movesx()/moveb()/move_spiral()/amovel()/amovec()/amove
sx()/amoveb()/amove_spiral()`



8.13 set_tcp(name)

▪ **Features**

This function calls the name of the TCP registered in the Teach Pendant and sets it as the current TCP.

▪ **Parameters**

Parameter Name	Data Type	Default Value	Description
name	string	-	Name of the TCP registered in the TP.

▪ **Return**

Value	Description
0	Success
Negative value	Failed

▪ **Exception**

Exception	Description
DR_Error (DR_ERROR_TYPE)	Parameter data type error occurred
DR_Error (DR_ERROR_VALUE)	Parameter value is invalid
DR_Error (DR_ERROR_RUNTIME)	C extension module error occurred
DR_Error (DR_ERROR_STOP)	Program terminated forcefully

▪ **Example**

```
P0 = posj(0,0,90,0,90,0)
movej(P0)
set_tcp("tcp1") # The TCP data registered as tcp1 in the TP is called and set to the
current TCP value.
P1 = posx(400,500,800,0,180,0)
movej(P1, vel=10, acc=20) # Moves the recognized center of the tool to the P1
position.
```

▪ **Related commands**

fkin()/ikin()/movej()/movejx()/movec()/movesx()/moveb()/amovej()/amovejx()/
amovec()/amovesx()/amoveb()



8.14 set_ref_coord(coord)

8.15 movej

▪ Features

The robot moves to the target joint position (pos) from the current joint position.

▪ Parameters

Parameter Name	Data Type	Default Value	Description
pos	posj	-	posj or
	list (float[6])		joint angle list
vel (v)	float	None	velocity (same to all axes) or
	list (float[6])	None	velocity (to an axis)
acc (a)	float	None	acceleration (same to all axes) or
	list (float[6])	None	acceleration (acceleration to an axis)
time (t)	float	None	Reach time [sec]
radius (r)	float	None	Radius for blending
mod	int	DR_MV_MOD_ABS	Movement basis • DR_MV_MOD_ABS: Absolute • DR_MV_MOD_REL: Relative
Ra	int	DR_MV_RA_DUPLICATE	Reactive motion mode • DR_MV_RA_DUPLICATE: duplicate • DR_MV_RA_OVERRIDE: override

Note

- Abbreviated parameter names are supported. (v:vel, a:acc, t:time, r:radius)
- `_global_velj` is applied if vel is None. (The initial value of `_global_velj` is 0.0 and can be set by `set_velj`.)
- `_global_accj` is applied if acc is None. (The initial value of `_global_accj` is 0.0 and can be set by `set_accj`.)
- If the time is specified, values are processed based on time, ignoring vel and acc.
- If the time is None, it is set to 0.
- If the radius is None, it is set to the blending radius in the blending section and 0 otherwise.

⚠ Caution

If the following motion is blended with the conditions of `ra=DR_MV_RA_DUPLICATE` and `radius>0`, the preceding motion can be terminated when the following motion is terminated while the remaining motion time determined by the remaining distance, velocity, and acceleration of the preceding motion is greater than the motion time of the following motion. Refer to the following image for more information.

< (Example) Path differences accord. to 1st and 2nd motion settings >

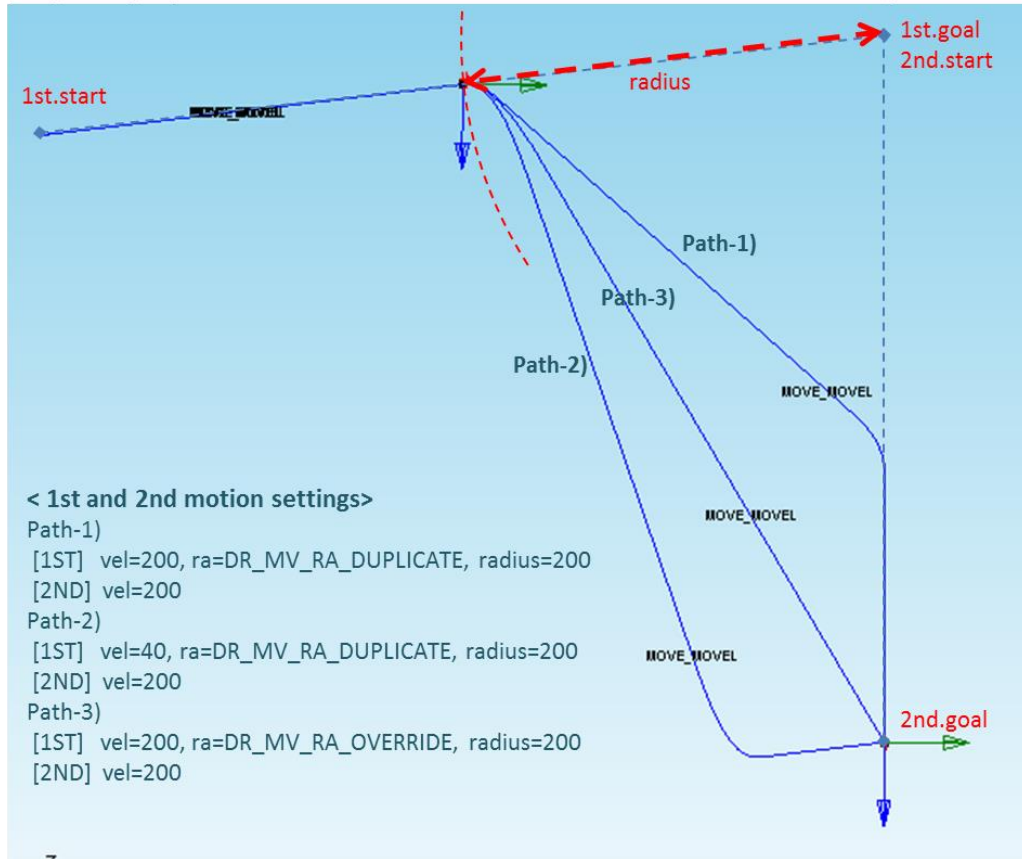

▪ **Return**

Value	Description
0	Success
Negative value	Failed

▪ Exception

Exception	Description
DR_Error (DR_ERROR_TYPE)	Parameter data type error occurred
DR_Error (DR_ERROR_VALUE)	Parameter value is invalid
DR_Error (DR_ERROR_RUNTIME)	C extension module error occurred
DR_Error (DR_ERROR_STOP)	Program terminated forcefully

▪ Example

```

Q1 = posj(0,0,90,0,90,0)
Q2 = posj(0,0,0,0,90,0)
movej(Q1, vel=10, acc=20)
    # Moves to the Q1 joint angle at the velocity of 10(deg/sec) and acceleration of
    # 20(deg/sec2).
movej(Q2, time=5)
    # Moves to the Q2 joint angle with a reach time of 5 sec.
movej(Q1, v=30, a=60, r=200)
    # Moves to the Q1 joint angle and is set to execute the next motion
    # when the distance from the Q1 space position is 200mm.
movej(Q2, v=30, a=60, ra= DR_MV_RA_OVERRIDE)
    # Immediately terminates the last motion and blends it to move to the Q2 joint
    # angle.

```

▪ Related commands

`posj()/set_velj()/set_accj()/amovej()`

8.16 movel

▪ Features

The robot moves along the straight line to the target position (pos) within the task space.

▪ Parameters

Parameter Name	Data Type	Default Value	Description
pos	posx	-	posx or position list
	list (float[6])		
vel (v)	float	None	velocity or
	list (float[2])	None	velocity1, velocity2
acc (a)	float	None	acceleration or
	list (float[2])	None	acceleration1, acceleration2
time (t)	float	None	Reach time [sec] * If the time is specified, values are processed based on time, ignoring vel and acc.
radius (r)	float	None	Radius for blending
ref	int	None	reference coordinate <ul style="list-style-type: none"> • DR_BASE: base coordinate • DR_WORLD: world coordinate • DR_TOOL: tool coordinate • user coordinate: User defined
mod	int	DR_MV_MOD_ABS	Movement basis <ul style="list-style-type: none"> • DR_MV_MOD_ABS: Absolute • DR_MV_MOD_REL: Relative
ra	int	DR_MV_RA_DUPLICATE	Reactive motion mode <ul style="list-style-type: none"> • DR_MV_RA_DUPLICATE: duplicate • DR_MV_RA_OVERRIDE: override

Note

- Abbreviated parameter names are supported. (v:vel, a:acc, t:time, r:radius)
- `_global_velx` is applied if vel is None. (The initial value of `_global_velx` is 0.0 and can be set by `set_velx`.)

- `_global_accx` is applied if `acc` is `None`. (The initial value of `_global_accx` is 0.0 and can be set by `set_accx`.)
- If an argument is inputted to `vel` (e.g., `vel=30`), the input argument corresponds to the linear velocity of the motion while the angular velocity is determined proportionally to the linear velocity.
- If an argument is inputted to `acc` (e.g., `acc=60`), the input argument corresponds to the linear acceleration of the motion while the angular acceleration is determined proportionally to the linear acceleration.
- If the time is specified, values are processed based on time, ignoring `vel` and `acc`.
- If the time is `None`, it is set to 0.
- If the radius is `None`, it is set to the blending radius in the blending section and 0 otherwise.
- `_g_coord` is applied if the `ref` is `None`. (The initial value of `_g_coord` is `DR_BASE`, and it can be set by the `set_ref_coord` command.)
- **The `DR_WORLD` argument of `ref` is only available in M2.40 or later versions.**

Caution

If the following motion is blended with the conditions of `ra=DR_MV_RA_DUPLICATE` and `radius>0`, the preceding motion can be terminated when the following motion is terminated while the remaining motion time determined by the remaining distance, velocity, and acceleration of the preceding motion is greater than the motion time of the following motion. Refer to the following image for more information.

< (Example) Path differences accord. to 1st and 2nd motion settings >

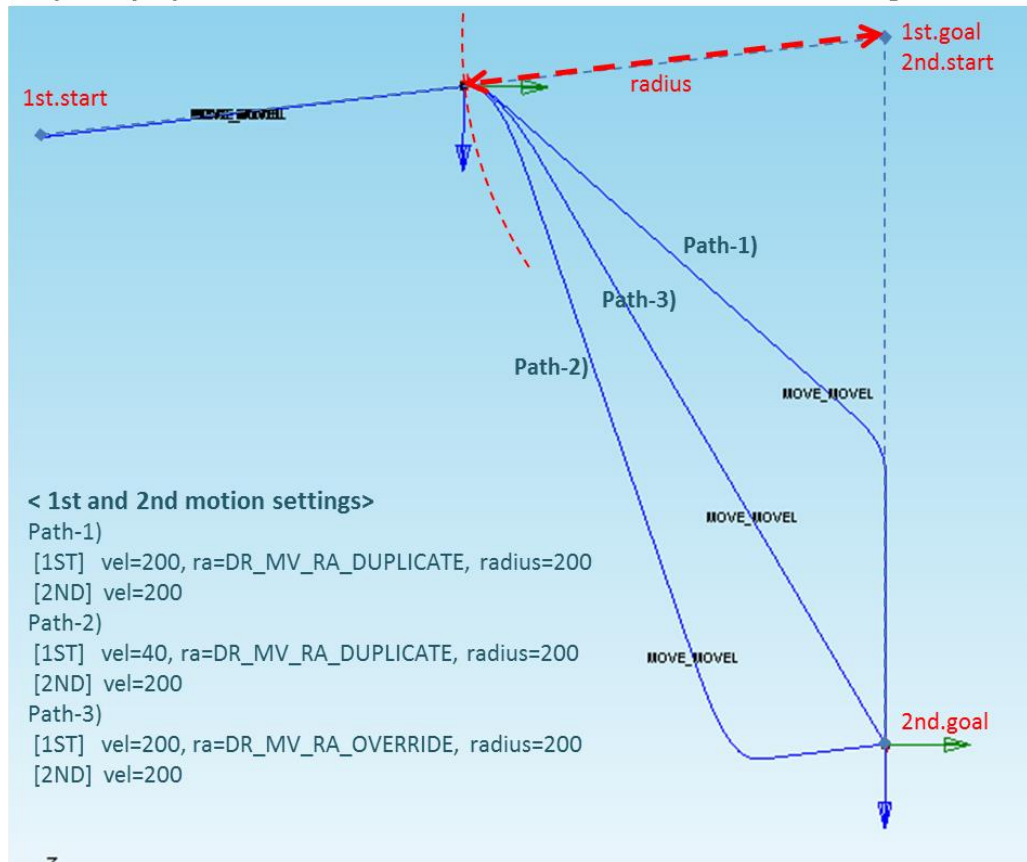

Return

Value	Description
0	Success
Negative value	Failed

Exception

Exception	Description
DR_Error (DR_ERROR_TYPE)	Parameter data type error occurred
DR_Error (DR_ERROR_VALUE)	Parameter value is invalid
DR_Error (DR_ERROR_RUNTIME)	C extension module error occurred
DR_Error (DR_ERROR_STOP)	Program terminated forcefully



▪ Example

```
P0 = posj(0,0,90,0,90,0)
movej(P0, v=30, a=30)
P1 = posx(400,500,800,0,180,0)
P2 = posx(400,500,500,0,180,0)
P3 = posx(30,30,30,0,0,0)
movej(P1, vel=30, acc=100)
    # Moves to the P1 position with a velocity of 30(mm/sec) and acceleration of
    # 100(mm/sec2).
movej(P2, time=5)
    # Moves to the P2 position with a reach time of 5 sec.
movej(P3, time=5, ref=DR_TOOL, mod=DR_MV_MOD_REL)
    # Moves the robot from the start position to the relative position of P3 in the tool
    # coordinate system
    # with a reach time of 5 sec.
movej(P2, time=5, r=10)
    # Moves the robot to the P2 position with a reach time of 5 seconds,
    # and the next motion is executed when the distance from the P2 position is
    # 10mm.
```

▪ Related commands

`posx()/set_velx()/set_accx()/set_tcp()/set_ref_coord()/amovej()`

8.17 movejx

▪ Features

The robot moves to the target position (pos) within the joint space.

Since the target position is inputted as a posx form in the task space, it moves in the same way as movel. However, since this robot motion is performed in the joint space, it does not guarantee a linear path to the target position. In addition, one of 8 types of joint combination (robot configurations) corresponding to the task space coordinate system (posx) must be specified in sol (solution space).

▪ Parameters

Parameter Name	Data Type	Default Value	Description
pos	posx	-	posx or position list
	list (float[6])		
vel (v)	float	None	velocity (same to all axes) or velocity (to an axis)
	list (float[6])	None	
acc (a)	float	None	acceleration (same to all axes) or acceleration (acceleration to an axis)
	list (float[6])	None	
time (t)	float	None	Reach time [sec]
radius (r)	float	None	Radius for blending
ref	int	None	reference coordinate <ul style="list-style-type: none"> • DR_BASE: base coordinate • DR_WORLD: world coordinate • DR_TOOL: tool coordinate • user coordinate: User defined
mod	int	DR_MV_MOD_ABS	Movement basis <ul style="list-style-type: none"> • DR_MV_MOD_ABS: Absolute • DR_MV_MOD_REL: Relative
ra	int	DR_MV_RA_DUPLICATE	Reactive motion mode <ul style="list-style-type: none"> • DR_MV_RA_DUPLICATE: duplicate • DR_MV_RA_OVERRIDE: override
sol	int	0	Solution space

 **Note**

- Abbreviated parameter names are supported. (v:vel, a:acc, t:time, r:radius)
- `_global_velj` is applied if `vel` is None. (The initial value of `_global_velj` is 0.0 and can be set by `set_velj`.)
- `_global_accj` is applied if `acc` is None. (The initial value of `_global_accj` is 0.0 and can be set by `set_accj`.)
- If the time is specified, values are processed based on time, ignoring `vel` and `acc`.
- If the time is None, it is set to 0.
- If the radius is None, it is set to the blending radius in the blending section and 0 otherwise.
- `_g_coord` is applied if the `ref` is None. (The initial value of `_g_coord` is `DR_BASE`, and it can be set by the `set_ref_coord` command.)
- **The `DR_WORLD` argument of `ref` is only available in M2.40 or later versions.**
- Using the blending in the preceding motion generates an error in the case of input with relative motion (`mod=DR_MV_MOD_REL`), and it is recommended to blend using `movej()` or `movel()`.
- Refer to the description of `movej()` and `movel()` for blending according to option `ra` and `vel/acc`.

▪ **Robot configuration (shape vs. solution space)**

Solution space	Binary	Shoulder	Elbow	Wrist
0	000	Lefty	Below	No Flip
1	001	Lefty	Below	Flip
2	010	Lefty	Above	No Flip
3	011	Lefty	Above	Flip
4	100	Righty	Below	No Flip
5	101	Righty	Below	Flip
6	110	Righty	Above	No Flip
7	111	Righty	Above	Flip

▪ **Return**

Value	Description
0	Success
Negative value	Error

▪ Exception

Exception	Description
DR_Error (DR_ERROR_TYPE)	Parameter data type error occurred
DR_Error (DR_ERROR_VALUE)	Parameter value is invalid
DR_Error (DR_ERROR_RUNTIME)	C extension module error occurred
DR_Error (DR_ERROR_STOP)	Program terminated forcefully

▪ Example

```

P0 = posj(0,0,90,0,90,0)
movej(P0, v=30, a=30)
P1 = posx(400,500,800,0,180,0)
P2 = posx(400,500,500,0,180,0)
movel(P2, vel=100, acc=200)      # Linear movement to P2
X_tmp, sol_init = get_current_posx() # Obtains the current solution space from the P2 position
movejx(P1, vel=30, acc=60, sol=sol_init)
# Moves to the joint angle with a velocity and acceleration of 30(deg/sec) and
# 60(deg/sec2), respectively,
# when the TCP edge is the P1 position (maintaining the solution space in the last P2
# position)
movejx(P2, time=5, sol=2)
# Moves to the joint angle with a reach time of 5 sec when the TCP edge is at the P2
# position
# (forcefully sets a solution space to 2)
movejx(P1, vel=[10, 20, 30, 40, 50, 60], acc=[20, 20, 30, 30, 40, 40], radius=100, sol=2)
# Moves the robot to the joint angle when the TCP edge is at the P1 position,
# and the next motion is executed when the distance from the P2 position is 100mm.
movejx(P2, v=30, a=60, ra= DR_MV_RA_OVERRIDE, sol=2)
# Immediately terminates the last motion and blends it to move to the joint angle
# when the TCP edge is at the P2 position.

```

▪ Related commands

`posx()/set_velj()/set_accj()/get_current_posx()/amovejx()`

8.18 movec

▪ Features

The robot moves along an arc to the target pos (pos2) via a waypoint (pos1) or to a specified angle from the current position in the task space.

▪ Parameters

Parameter Name	Data Type	Default Value	Description
pos	posj	-	posx or position list
	list (float[6])		
pos2	posx		posx or position list
	list (float[6])		
vel (v)	float	None	velocity or velocity1, velocity2
	list (float[2])	None	
acc (a)	float	None	acceleration or acceleration1, acceleration2
	list (float[2])	None	
time (t)	float	None	Reach time [sec]
radius (r)	float	None	Radius for blending
ref	int	None	reference coordinate <ul style="list-style-type: none"> • DR_BASE: base coordinate • DR_WORLD: world coordinate • DR_TOOL: tool coordinate • user coordinate: User defined
mod	int	DR_MV_MOD_ABS	Movement basis <ul style="list-style-type: none"> • DR_MV_MOD_ABS: Absolute • DR_MV_MOD_REL: Relative
angle (an)	float	None	angle or angle1, angle2
	list (float[2])		
ra	int	DR_MV_RA_DUPLICATE	Reactive motion mode <ul style="list-style-type: none"> • DR_MV_RA_DUPLICATE: duplicate • DR_MV_RA_OVERRIDE: override

 **Note**

- Abbreviated parameter names are supported. (v:vel, a:acc, t:time, r:radius, angle:an)
- `_global_velx` is applied if `vel` is None. (The initial value of `_global_velx` is 0.0 and can be set by `set_velx`.)
- `_global_accx` is applied if `acc` is None. (The initial value of `_global_accx` is 0.0 and can be set by `set_accx`.)
- If an argument is inputted to `vel` (e.g., `vel=30`), the input argument corresponds to the linear velocity of the motion while the angular velocity is determined proportionally to the linear velocity.
- If an argument is inputted to `acc` (e.g., `acc=60`), the input argument corresponds to the linear acceleration of the motion while the angular acceleration is determined proportionally to the linear acceleration.
- If the time is specified, values are processed based on time, ignoring `vel` and `acc`.
- If the time is None, it is set to 0.
- If the radius is None, it is set to the blending radius in the blending section and 0 otherwise.
- `_g_coord` is applied if the `ref` is None. (The initial value of `_g_coord` is `DR_BASE`, and it can be set by the `set_ref_coord` command.)
- **The `DR_WORLD` argument of `ref` is only available in M2.40 or later versions.**
- If the `mod` is `DR_MV_MOD_REL`, `pos1` and `pos2` are defined in the relative coordinate system of the previous `pos`. (`pos1` is the relative coordinate from the starting point while `pos2` is the relative coordinate from `pos1`.)
- If the angle is None, it is set to 0.
- If only one angle is inputted, the total rotated angle on the circular path is applied to the angle.
- If two angle values are inputted, `angle1` refers to the total rotating angle moving at a constant velocity on the circular path while `angle2` refers to the rotating angle in the rotating section for acceleration and deceleration. In that case, the total moving angle `angle1 + 2 X angle2` moves along the circular path.

 **Caution**

If the following motion is blended with the conditions of `ra=DR_MV_RA_DUPLICATE` and `radius>0`, the preceding motion can be terminated when the following motion is terminated while the remaining motion time determined by the remaining distance, velocity, and acceleration of the preceding motion is greater than the motion time of the following motion. Refer to the following image for more information.

< (Example) Path differences accord. to 1st and 2nd motion settings >

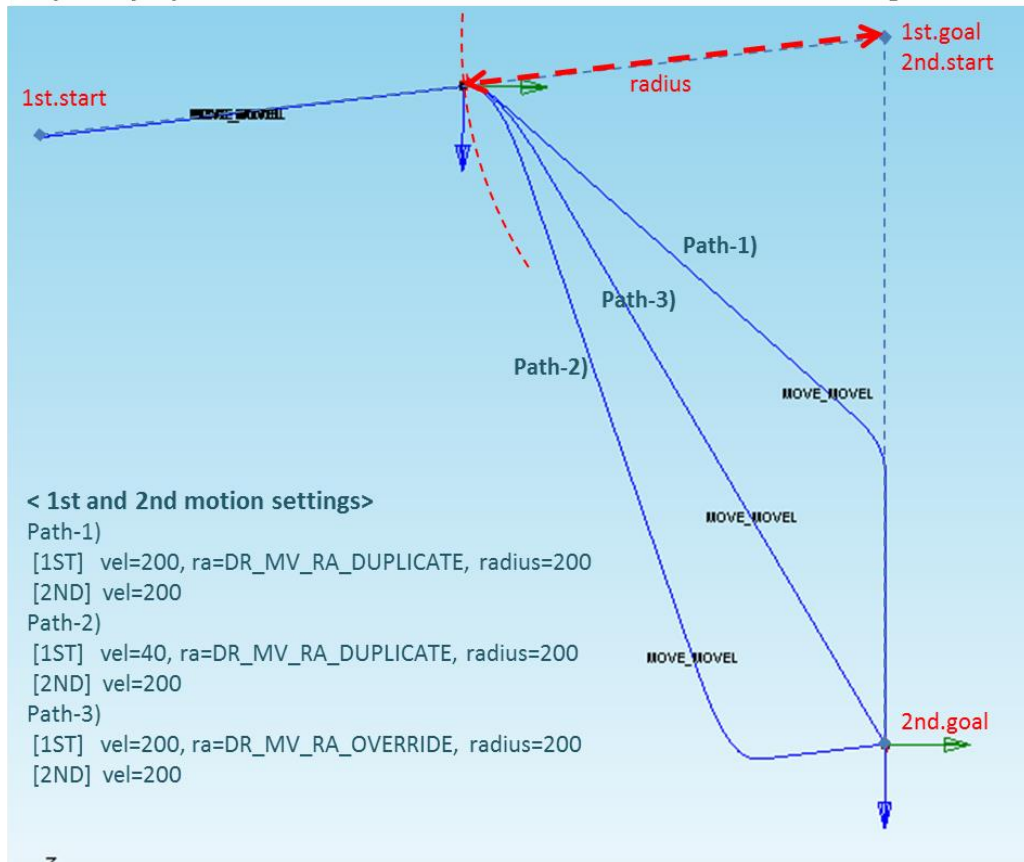

▪ Return

Value	Description
0	Success
Negative value	Error

▪ Exception

Exception	Description
DR_Error (DR_ERROR_TYPE)	Parameter data type error occurred
DR_Error (DR_ERROR_VALUE)	Parameter value is invalid
DR_Error (DR_ERROR_RUNTIME)	C extension module error occurred
DR_Error (DR_ERROR_STOP)	Program terminated forcefully

▪ Example

```
#1
P0 = posj(0,0,90,0,90,0)
movej(P0)
set_velx(30,20) # Set the global task velocity to 30(mm/sec) and 20(deg/sec).
set_accx(60,40) # Set the global task acceleration to 60(mm/sec2) and 40(deg/sec2).

P1 = posx(400,500,800,0,180,0)
P2 = posx(400,500,500,0,180,0)
P3 = posx(100, 300, 700, 45, 0, 0)
P4 = posx(500, 400, 800, 45, 45, 0)

movec(P1, P2, vel=30)
# Moves to P2 with a velocity of 30(mm/sec) and global acceleration of 60(mm/sec2)
# via P1 along the arc trajectory.
movej(P0)
movec(P3, P4, vel=30, acc=60)
# Moves to P4 with a velocity of 30(mm/sec) and acceleration of 60(mm/sec2).
# via P3 along the arc trajectory
movej(P0).
movec(P2, P1, time=5)
# Moves with a global velocity of 30(mm/sec) and acceleration of 60(mm/sec2).
# to P1 along the arc trajectory via P2 at the 5-second point.
movec(P3, P4, time=3, radius=100)
# Moves along the arc trajectory to P4 via P3 with a reach time of 3 seconds
# and then executes the next motion at a distance of 100mm from the P4 position.
movec(P2, P1, ra=DR_MV_RA_OVERRIDE)
# Immediately terminates the last motion and blends it to move to the P1 position.
```

▪ Related commands

`posx()/set_velx()/set_accx()/set_tcp()/set_ref_coord()/amovec()`

8.19 movesj

▪ Features

The robot moves along a spline curve path that connects the current position to the target position (the last waypoint in pos_list) via the waypoints of the joint space input in pos_list.

The input velocity/acceleration means the maximum velocity/acceleration in the path, and the acceleration and deceleration during the motion are determined according to the position of the waypoint.

▪ Parameters

Parameter Name	Data Type	Default Value	Description
pos_list	list (posj)	-	posj list
vel (v)	float	None	velocity (same to all axes) or
	list (float[6])		velocity (to an axis)
acc (a)	float	None	acceleration (same to all axes) or
	list (float[6])		acceleration (acceleration to an axis)
time (t)	float	None	Reach time [sec]
mod	int	DR_MV_MOD_ABS	Movement basis • DR_MV_MOD_ABS: Absolute • DR_MV_MOD_REL: Relative

Note

- Abbreviated parameter names are supported. (v:vel, a:acc, t:time)
- `_global_velj` is applied if vel is None. (The initial value of `_global_velj` is 0.0 and can be set by `set_velj`.)
- `_global_accj` is applied if acc is None. (The initial value of `_global_accj` is 0.0 and can be set by `set_accj`.)
- If the time is specified, values are processed based on time, ignoring vel and acc.
- If the time is None, it is set to 0.
- If the mod is `DR_MV_MOD_REL`, each pos in the pos_list is defined in the relative coordinate of the previous pos. (If pos_list=[q1, q2, ...,q(n-1), q(n)], q1 is the relative angle of the starting point while q(n) is the relative coordinate of q(n-1).)
- This function does not support online blending of previous and subsequent motions.

Return

Value	Description
0	Success
Negative value	Error

Exception

Exception	Description
DR_Error (DR_ERROR_TYPE)	Parameter data type error occurred
DR_Error (DR_ERROR_VALUE)	Parameter value is invalid
DR_Error (DR_ERROR_RUNTIME)	C extension module error occurred
DR_Error (DR_ERROR_STOP)	Program terminated forcefully

Example

```
#CASE 1) Absolute angle input (mod= DR_MV_MOD_ABS)
q0 = posj(0,0,0,0,0,0)
movej(q0, vel=30, acc=60)      # Moves in joint motion to the initial position (q0).
q1 = posj(10, -10, 20, -30, 10, 20)      # Defines the posj variable (joint angle) q1.
q2 = posj(25, 0, 10, -50, 20, 40)
q3 = posj(50, 50, 50, 50, 50, 50)
q4 = posj(30, 10, 30, -20, 10, 60)
q5 = posj(20, 20, 40, 20, 0, 90)

qlist = [q1, q2, q3, q4, q5]      # Defines the list (qlist) which is a set of q1-q5 as the
waypoints.

movesj(qlist, vel=30, acc=100)
    # Moves the spline curve that connects the waypoints defined in the qlist.
    # with a maximum velocity of 30(mm/sec) and maximum acceleration of
    100(mm/sec2)
```

```
#CASE 2) Relative angle input (mod= DR_MV_MOD_REL)
q0 = posj(0,0,0,0,0,0)
movej(q0, vel=30, acc=60)      # Moves in joint motion to the initial position (q0).
dq1 = posj(10, -10, 20, -30, 10, 20)      # Defines dq1 (q1=q0+dq1) as the relative
joint angle of q0
dq2 = posj(15, 10, -10, -20, 10, 20)      # Defines dq2 (q2=q1+dq2) as the relative
joint angle of q1
dq3 = posj(25, 50, 40, 100, 30, 10)      # Defines dq3 (q3=q2+dq3) as the relative
joint angle of q2
dq4 = posj(-20, -40, -20, -70, -40, 10)      # Defines dq4 (q4=q3+dq4) as the relative
```



```
joint angle of q3
dq5 = posj(-10, 10, 10, 40, -10, 30)    # Defines dq5 (q5=q4+dq5) as the relative
joint angle of q4

dqlist = [dq1, dq2, dq3, dq4, dq5]
    # Defines the list (dqlist) which is a set of q1-q5 as the relative waypoints.

movesj(dqlist, vel=30, acc=100, mod= DR_MV_MOD_REL )
    # Moves the spline curve that connects the relative waypoints defined in the
    dqlist
    # with a maximum velocity of 30(mm/sec) and maximum acceleration of
    100(mm/sec2) (same motion as CASE-1).
```

▪ Related commands

`posj()/set_velj()/set_accj()/movesj()`

8.20 movesx

▪ Features

The robot moves along a spline curve path that connects the current position to the target position (the last waypoint in pos_list) via the waypoints of the task space input in pos_list.

The input velocity/acceleration means the maximum velocity/acceleration in the path and the constant velocity motion is performed with the input velocity according to the condition if the option for the constant speed motion is selected.

▪ Parameters

Parameter Name	Data Type	Default Value	Description
pos_list	list (posx)	-	posx list
vel (v)	float	None	velocity or velocity1, velocity2
	list (float[2])		
acc (a)	float	None	acceleration or acceleration1, acceleration2
	list (float[2])		
time (t)	float	None	Reach time [sec]
ref	int	None	reference coordinate <ul style="list-style-type: none"> • DR_BASE: base coordinate • DR_WORLD: world coordinate • DR_TOOL: tool coordinate • user coordinate: User defined
mod	int	DR_MV_MOD_ABS	Movement basis <ul style="list-style-type: none"> • DR_MV_MOD_ABS: Absolute • DR_MV_MOD_REL: Relative
vel_opt	int	DR_MVS_VEL_NONE	Velocity option <ul style="list-style-type: none"> • DR_MVS_VEL_NONE: None • DR_MVS_VEL_CONST: Constant velocity

Note

- Abbreviated parameter names are supported. (v:vel, a:acc, t:time)
- `_global_vel` is applied if `vel` is None. (The initial value of `_global_vel` is 0.0 and can be set by `set_vel`.)
- `_global_accx` is applied if `acc` is None. (The initial value of `_global_accx` is 0.0 and can be set by `set_accx`.)
- If an argument is inputted to `vel` (e.g., `vel=30`), the input argument corresponds to the linear velocity of the motion while the angular velocity is determined proportionally to the linear velocity.
- If an argument is inputted to `acc` (e.g., `acc=60`), the input argument corresponds to the linear acceleration of the motion while the angular acceleration is determined proportionally to the linear acceleration.
- If the time is specified, values are processed based on time, ignoring `vel` and `acc`.
- If the time is None, it is set to 0.
- `_g_coord` is applied if the `ref` is None. (The initial value of `_g_coord` is `DR_BASE`, and it can be set by the `set_ref_coord` command.)
- **The `DR_WORLD` argument of `ref` is only available in M2.40 or later versions.**
- If the `mod` is `DR_MV_MOD_REL`, each `pos` in the `pos_list` is defined in the relative coordinate of the previous `pos`. (If `pos_list=[p1, p2, ..., p(n-1), p(n)]`, `p1` is the relative angle of the starting point while `p(n)` is the relative coordinate of `p(n-1)`.)
- This function does not support online blending of previous and subsequent motions.

Caution

The constant velocity motion according to the distance and velocity between the waypoints cannot be used if the “`vel_opt= DR_MVS_VEL_CONST`” option (constant velocity option) is selected, and the motion is automatically switched to the variable velocity motion (`vel_opt= DR_MVS_VEL_NONE`) in that case.

Return

Value	Description
0	Success
Negative value	Error

Exception

Exception	Description
<code>DR_Error (DR_ERROR_TYPE)</code>	Parameter data type error occurred
<code>DR_Error (DR_ERROR_VALUE)</code>	Parameter value is invalid
<code>DR_Error (DR_ERROR_RUNTIME)</code>	C extension module error occurred

Exception	Description
DR_Error (DR_ERROR_STOP)	Program terminated forcefully

▪ Example

```
#CASE 1) Absolute coordinate input (mod= DR_MV_MOD_ABS)
P0 = posj(0,0,90,0,90,0)
movej(P0, v=30, a=30)
x0 = posx(600, 43, 500, 0, 180, 0)      # Defines the posx variable (space
coordinate/pose) x0.
movel(x0, vel=100, acc=200)      # Linear movement to the initial position x0
x1 = posx(600, 600, 600, 0, 175, 0)      # Defines the posx variable (space
coordinate/pose) x1.
x2 = posx(600, 750, 600, 0, 175, 0)
x3 = posx(150, 600, 450, 0, 175, 0)
x4 = posx(-300, 300, 300, 0, 175, 0)
x5 = posx(-200, 700, 500, 0, 175, 0)
x6 = posx(600, 600, 400, 0, 175, 0)

xlist = [x1, x2, x3, x5, x6]      # Defines the list (xlist) which is a set of x1-x6 as the
waypoints.

movesx(xlist, vel=[100, 30], acc=[200, 60], vel_opt=DR_MVS_VEL_NONE)
    # Moves the spline curve that connects the waypoints defined in the xlist
    # with a maximum velocity of 100, 30(mm/sec, deg/sec) and maximum
acceleration of 200(mm/sec2) and
    # 60(deg/sec2).
movesx(xlist, vel=[100, 30], acc=[200, 60], time=5, vel_opt=DR_MVS_VEL_CONST)
    # Moves the spline curve that connects the waypoints defined in the xlist
    # with a constant velocity of 100, 30(mm/sec, deg/sec).
```

```
#CASE 2) Relative coordinate input (mod= DR_MV_MOD_REL)
P0 = posj(0,0,90,0,90,0)
movej(P0)
x0 = posx(600, 43, 500, 0, 180, 0)      # Defines the posx variable (space
coordinate/pose) x0.
movel(x0, vel=100, acc=200)      # Linear movement to the initial position x0
dx1 = posx(0, 557, 100, 0, -5, 0)
    # Definition of relative coordinate dx1 to x0 (Homogeneous transformation of
dx1 based in x1= x0)
dx2 = posx(0, 150, 0, 0, 0, 0)
    # Definition of relative coordinate dx2 to x1 (Homogeneous transformation of dx2
based in x2= x1)
dx3 = posx(-450, -150, -150, 0, 0, 0)
    # Definition of relative coordinate dx3 to x2 (Homogeneous transformation of dx3
based in x3= x2)
dx4 = posx(-450, -300, -150, 0, 0, 0)
    # Definition of relative coordinate dx4 to x3 (Homogeneous transformation of dx4
based in x4= x3)
```



```
dx5 = posx(100, 400, 200, 0, 0, 0)
      # Definition of relative coordinate dx5 to x4 (Homogeneous transformation of dx5
      based in x5= x4)
dx6 = posx(800, -100, -100, 0, 0, 0)
      # Definition of relative coordinate dx6 to x5 (Homogeneous transformation of dx6
      based in x6= x5)

dxlist = [dx1, dx2, dx3, dx4, dx5, dx6]
      # Defines the list (dxlist) which is a set of dx1-dx6 as the waypoints.

movesx(dxlist, vel=[100, 30], acc=[200, 60], mod= DR_MV_MOD_REL,
      vel_opt=DR_MVS_VEL_NONE)
      # Moves the spline curve that connects the waypoints defined in the dxlist
      # with a maximum velocity of 100, 30 (mm/sec, deg/sec)
      # and maximum acceleration of 200(mm/sec2), and 60(deg/sec2) (same motion
      as CASE-1).
```

- **Related commands**

`posx()/set_velx()/set_accx()/set_tcp()/set_ref_coord()/amovesx()`

8.21 moveb

▪ Features

This function takes a list that has one or more path segments (line or circle) as arguments and moves at a constant velocity by blending each segment into the specified radius. Here, the radius can be set through posb.

▪ Parameters

Parameter Name	Data Type	Default Value	Description
pos_list	list (posb)	-	posb list
vel (v)	float	None	velocity or velocity1, velocity2
	list (float[2])		
acc (a)	float	None	acceleration or acceleration1, acceleration2
	list (float[2])		
time (t)	float	None	Reach time [sec] * If the time is specified, values are processed based on time, ignoring vel and acc.
ref	int	None	reference coordinate <ul style="list-style-type: none"> • DR_BASE: base coordinate • DR_WORLD: world coordinate • DR_TOOL: tool coordinate • user coordinate: User defined
mod	int	DR_MV_MOD_ABS	Movement basis <ul style="list-style-type: none"> • DR_MV_MOD_ABS: Absolute • DR_MV_MOD_REL: Relative

Note

- Abbreviated parameter names are supported. (v:vel, a:acc, t:time)
- Up to 50 arguments can be entered in posb_list.
- `_global_velx` is applied if `vel` is None. (The initial value of `_global_velx` is 0.0 and can be set by `set_velx`.)
- `_global_accx` is applied if `acc` is None. (The initial value of `_global_accx` is 0.0 and can be set by `set_accx`.)
- If an argument is inputted to `vel` (e.g., `vel=30`), the input argument corresponds to the linear velocity of the motion while the angular velocity is determined proportionally to the linear velocity.
- If an argument is inputted to `acc` (e.g., `acc=60`), the input argument corresponds to the linear acceleration of the motion while the angular acceleration is determined proportionally to the linear acceleration.
- If the time is specified, values are processed based on time, ignoring `vel` and `acc`.
- If the time is None, it is set to 0.
- `_g_coord` is applied if the `ref` is None. (The initial value of `_g_coord` is `DR_BASE`, and it can be set by the `set_ref_coord` command.)
- **The `DR_WORLD` argument of `ref` is only available in M2.40 or later versions.**
- If the `mod` is `DR_MV_MOD_REL`, each `pos` in the `posb_list` is defined in the relative coordinate of the previous `pos`.

Caution

- A user input error is generated if the blending radius in `posb` is 0.
- A user input error is generated due to the duplicated input of Line if contiguous Line-Line segments have the same direction.
- A user input error is generated to prevent a sudden acceleration if the blending condition causes a rapid change in direction.
- This function does not support online blending of previous and subsequent motions.

Return

Value	Description
0	Success
Negative value	Error

Exception

Exception	Description
<code>DR_Error (DR_ERROR_TYPE)</code>	Parameter data type error occurred
<code>DR_Error (DR_ERROR_VALUE)</code>	Parameter value is invalid

Exception	Description
DR_Error (DR_ERROR_RUNTIME)	C extension module error occurred
DR_Error (DR_ERROR_STOP)	Program terminated forcefully

▪ Example

```
# Init Pose @ Jx1
Jx1 = posj(45,0,90,0,90,45)           # initial joint position
X0 = posx(370, 420, 650, 0, 180, 0)  # initial task position
```

```
# CASE 1) ABSOLUTE
# Absolute Goal Poses
X1 = posx(370, 670, 650, 0, 180, 0)
X1a = posx(370, 670, 400, 0, 180, 0)
X1a2= posx(370, 545, 400, 0, 180, 0)
X1b = posx(370, 595, 400, 0, 180, 0)
X1b2= posx(370, 670, 400, 0, 180, 0)
X1c = posx(370, 420, 150, 0, 180, 0)
X1c2= posx(370, 545, 150, 0, 180, 0)
X1d = posx(370, 670, 275, 0, 180, 0)
X1d2= posx(370, 795, 150, 0, 180, 0)

seg11 = posb(DR_LINE, X1, radius=20)
seg12 = posb(DR_CIRCLE, X1a, X1a2, radius=20)
seg14 = posb(DR_LINE, X1b2, radius=20)
seg15 = posb(DR_CIRCLE, X1c, X1c2, radius=20)
seg16 = posb(DR_CIRCLE, X1d, X1d2, radius=20)
b_list1 = [seg11, seg12, seg14, seg15, seg16]
# The blending radius of the last waypoint (seg16) is ignored.

movej(Jx1, vel=30, acc=60, mod=DR_MV_MOD_ABS)
# Joint motion to the initial angle (Jx1)
movel(X0, vel=150, acc=250, ref=DR_BASE, mod=DR_MV_MOD_ABS)
# Line motion to the initial position (X0)
moveb(b_list1, vel=150, acc=250, ref=DR_BASE, mod=DR_MV_MOD_ABS)
# Moves the robot from the current position through a trajectory consisting of
seg11(LINE), seg12(CIRCLE), seg14(LINE),
# seg15(CIRCLE), and seg16(CIRCLE) with a constant velocity of 150(mm/sec)
with the exception of accelerating and decelerating sections.
# (The final point is X1d2.) Blending to the next segment begins
# when the distance of 20mm from the end point (X1, X1a2, X1b2, X1c2, and
X1d2) of each segment
# is reached.
```

```
# CASE 2) RELATIVE
# Relative Goal Poses
```



```
dX1 = posx(0, 250, 0, 0, 0, 0)
dX1a = posx(0, 0, -150, 0, 0, 0)
dX1a2= posx(0, -125, 0, 0, 0, 0)
dX1b = posx(0, 50, 0, 0, 0, 0)
dX1b2= posx(0, 75, 0, 0, 0, 0)
dX1c = posx(0, -250, -250, 0, 0, 0)
dX1c2= posx(0, 125, 0, 0, 0, 0)
dX1d = posx(0, 125, 125, 0, 0, 0)
dX1d2= posx(0, 125, -125, 0, 0, 0)

dseg11 = posb(DR_LINE, dX1, radius=20)
dseg12 = posb(DR_CIRCLE, dX1a, dX1a2, radius=20)
dseg14 = posb(DR_LINE, dX1b2, radius=20)
dseg15 = posb(DR_CIRCLE, dX1c, dX1c2, radius=20)
dseg16 = posb(DR_CIRCLE, dX1d, dX1d2, radius=20)
db_list1 = [dseg11, dseg12, dseg14, dseg15, dseg16]
# The blending radius of the last waypoint (dseg16) is ignored.

movej(Jx1, vel=30, acc=60, mod=DR_MV_MOD_ABS)
# Joint motion to the initial angle (Jx1)
movel(X0, vel=150, acc=250, ref=DR_BASE, mod=DR_MV_MOD_ABS)
# Line motion to the initial position (X0)
moveb(b_list1, vel=150, acc=250, ref=DR_BASE, mod=DR_MV_MOD_ABS)
# Moves the robot from the current position through a trajectory consisting of
dseg11(LINE), dseg12(CIRCLE), dseg14(LINE),
# dseg15(CIRCLE), and dseg16(CIRCLE) with a constant velocity of
150(mm/sec) with the exception of accelerating and decelerating sections.
# (The final point is X1d2.)
# Blending to the next segment begins when the distance of 20mm from the end
point (X1, X1a2, X1b2, X1c2, and X1d2) of each segment is reached.
# (The path is the same as CASE#1.)
```

▪ Related commands

posb()/set_velx()/set_accx()/set_tcp()/set_ref_coord()/amoveb()

8.22 move_spiral

▪ Features

The radius increases in a radial direction and the robot moves in parallel with the rotating spiral motion in an axial direction. It moves the robot along the spiral trajectory on the surface that is perpendicular to the axis on the coordinate specified as ref and the linear trajectory in the axis direction.

▪ Parameters

Parameter Name	Data Type	Default Value	Range	Description
rev	float	10	rev > 0	Total number of revolutions
rmax	float	10	rmax > 0	Final spiral radius [mm]
lmax	float	0		Distance moved in the axis direction [mm]
vel (v)	float	None		velocity
acc (a)	float	None		acceleration
time (t)	float	None	time ≥ 0	Total execution time <sec>
axis	int	DR_AXIS_Z	-	axis • DR_AXIS_X: x-axis • DR_AXIS_Y: y-axis • DR_AXIS_Z: z-axis
ref	Int	DR_TOOL	-	reference coordinate • DR_BASE : base coordinate • DR_WORLD: world coordinate • DR_TOOL : tool coordinate • user coordinate: user defined

Note

- Abbreviated parameter names are supported. (v:vel, a:acc, t:time)
- rev refers to the total number of revolutions of the spiral motion.
- Rmax refers to the maximum radius of the spiral motion.
- Lmax refers to the parallel distance in the axis direction during the motion. A negative value means the parallel distance in the –axis direction.
- Vel refers to the moving velocity of the spiral motion.
- The first value of `_global_velx` (parallel velocity) is applied if `vel` is None. (The initial value of `_global_velx` is 0.0 and can be set by `set_velx`.)
- `acc` refers to the moving acceleration of the spiral motion.
- The first value of `_global_accx` (parallel acceleration) is applied if `acc` is None. (The initial value of `_global_accx` is 0.0 and can be set by `set_accx`.)
- If the time is specified, values are processed based on time, ignoring `vel` and `acc`.
- If the time is None, it is set to 0.
- The axis defines the axis that is perpendicular to the surface defined by the spiral motion.
- `Ref` refers to the reference coordinate system defined by the spiral motion.
- **The `DR_WORLD` argument of `ref` is only available in M2.40 or later versions.**
- This function does not support online blending of previous and subsequent motions.

Caution

- An error can be generated to ensure safe motion if the rotating acceleration calculated by the spiral path is too great.
In this case, reduce the `vel`, `acc`, or time value.

Return

Value	Description
0	Success
Negative value	Error

Exception

Exception	Description
<code>DR_Error (DR_ERROR_TYPE)</code>	Parameter data type error occurred
<code>DR_Error (DR_ERROR_VALUE)</code>	Parameter value is invalid
<code>DR_Error (DR_ERROR_RUNTIME)</code>	C extension module error occurred
<code>DR_Error (DR_ERROR_STOP)</code>	Program terminated forcefully

▪ **Example**

```
# hole search
# (A motion that completes 9.5 revolutions (rev) to the 50 mm radius (rmax) from 0 on
the Tool-X/Y surface as the center of the rotation in the Tool-Z direction and the spiral
trajectory that moves 50 mm (lmax) in the Tool-Z direction at the same time in 10
seconds from the initial position)

J00 = posj(0,0,90,0,60,0)
movej(J00,vel=30,acc=30)      # Joint movement to the initial pose
move_spiral(rev=9.5,rmax=20.0,lmax=50.0,time=20.0,axis=DR_AXIS_Z,ref=DR_TOOL
)
```

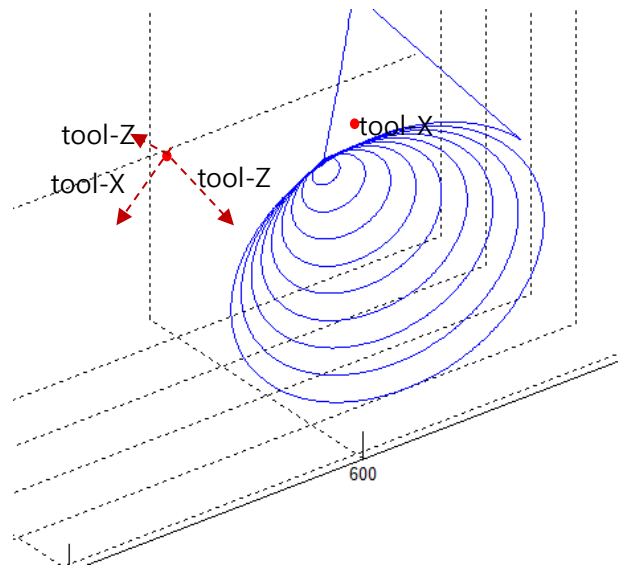

▪ **Related commands**

set_velx()/set_accx()/set_tcp()/set_ref_coord()/amove_spiral()

8.23 move_periodic

▪ Features

This function performs the cyclic motion based on the sine function of each axis (parallel and rotation) of the reference coordinate (ref) input as a relative motion that begins at the current position. The attributes of the motion on each axis are determined by the amplitude and period, and the acceleration/deceleration time and the total motion time are set by the interval and repetition count.

▪ Parameters

Parameter Name	Data Type	Default Value	Range	Description
amp	list (float[6])	-	$0 \leq \text{amp}$	Amplitude (motion between -amp and +amp) [mm] or [deg]
period	float or list (float[6])		$0 \leq \text{period}$	Period (time for 1 cycle) [sec]
atime	float	0.0	$0 \leq \text{atime}$	Acc-, dec- time [sec]
repeat	int	1	> 0	Repetition count
ref	int	DR_TOOL	-	reference coordinate <ul style="list-style-type: none"> • DR_BASE : base coordinate • DR_WORLD: world coordinate • DR_TOOL : tool coordinate • user coordinate: user defined

Note

- Amp refers to the amplitude. The input is a list of 6 elements which are the amp values for the axes (x, y, z, rx, ry, and rz). The amp input on the axis that does not have a motion must be 0.
- Period refers to the time needed to complete a motion in the direction, the amplitude. The input is a list of 6 elements which are the periods for the axes (x, y, z, rx, ry, and rz).
- Atime refers to the acceleration and deceleration time at the beginning and end of the periodic motion. The largest of the inputted acceleration/deceleration times and maximum period*1/4 is applied. An error is generated when the inputted acceleration/deceleration time exceeds 1/2 of the total motion time.
- Repeat refers to the number of repetitions of the axis (reference axis) that has the largest period value and determines the total motion time. The number of repetitions for each of the remaining axes is determined automatically according to the motion time.

- If the motion terminates normally, the motions for the remaining axes can be terminated before the reference axis's motion terminates so that the end position matches the starting position. The deceleration section will deviate from the previous path if the motions of all axes are not terminated at the same time. Refer to the following image for more information.

CASE-1) All-axis motions end at the same time

`move_periodic(amp=[100,100,0,0,0,0], period=[3.2,1.6,0,0,0,0], atime=3.1, repeat=2, ref=DR_BASE)`

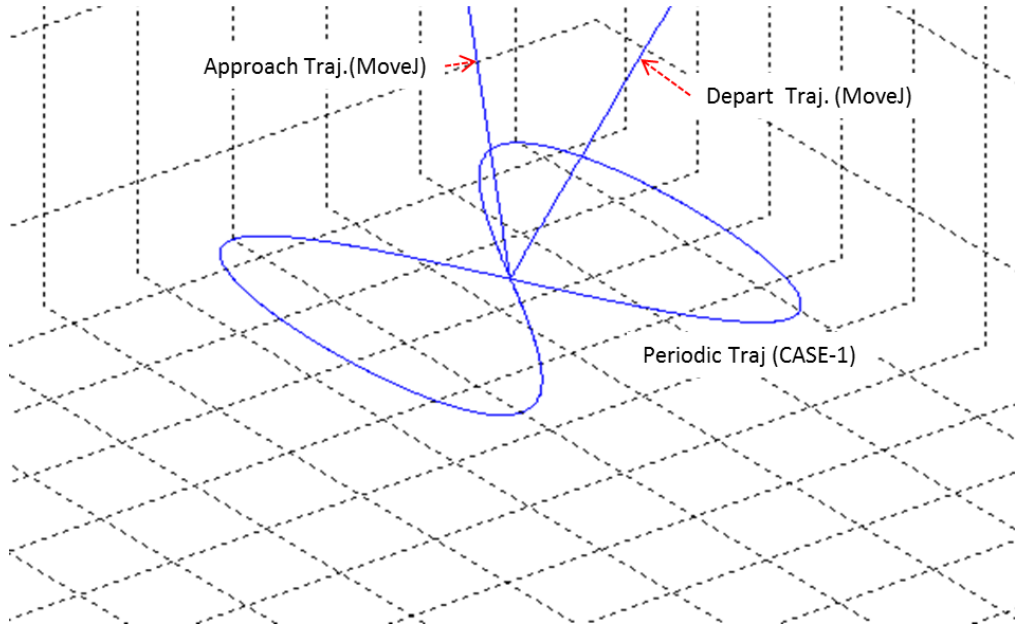

CASE-2) Diff-axis motions end individually

`move_periodic(amp=[100,100,0,0,0,0], period=[3.2,1.5,0,0,0,0], atime=0, repeat=2, ref=DR_BASE)`

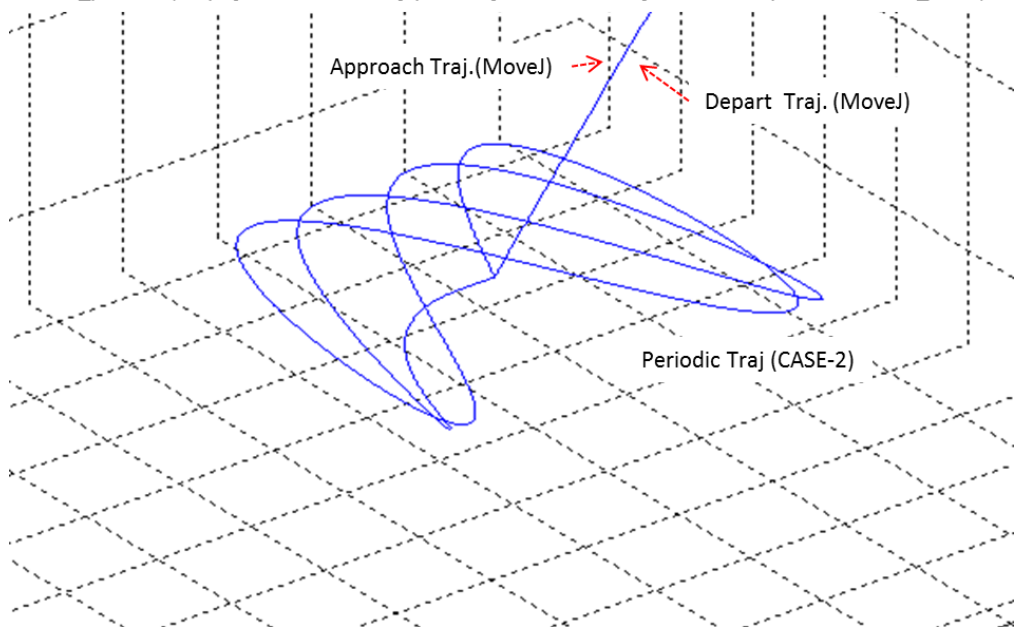



- Ref refers to the reference coordinate system of the repeated motion.
- **The DR_WORLD argument of ref is only available in M2.40 or later versions.**
- If a maximum velocity error is generated during a motion, adjust the amplification and period using the following formula.
Max. velocity = Amplification(amp)*2*pi(3.14)/Period(period) (i.e., Max. velocity=62.83mm/sec if amp=10mm and period=1 sec)
- This function does not support online blending of previous and subsequent motions.

Return

Value	Description
0	Success
Negative value	Error

Exception

Exception	Description
DR_Error (DR_ERROR_TYPE)	Parameter data type error occurred
DR_Error (DR_ERROR_VALUE)	Parameter value is invalid
DR_Error (DR_ERROR_RUNTIME)	C extension module error occurred
DR_Error (DR_ERROR_STOP)	Program terminated forcefully

Example

```
P0 = posj(0,0,90,0,90,0)
movej(P0)

#1
move_periodic(amp =[10,0,0,0,30,0], period=1.0, atime=0.2, repeat=5, ref=DR_TOOL)
# Repeats the x-axis (10mm amp and 1 sec. period) motion and rotating y-axis
(30deg amp and 1 sec. period) motion in the tool coordinate system
# totally, repeat the motion 5 times.

#2
move_periodic(amp =[10,0,20,0,0.5,0], period=[1,0,1.5,0,0,0], atime=0.5, repeat=3,
ref=DR_BASE)
# Repeats the x-axis (10mm amp and 1 sec. period) motion and z-axis (20mm
amp and 1.5 sec. period) motion in the base coordinate system
# 3 times. The rotating y-axis motion is not performed since its period is "0".
# The total motion time is about 5.5 sec. (1.5 sec. * 3 times + 1 sec. for
acceleration/deceleration) since the period of the x-axis motion is greater.
# The x-axis motion is repeated 4.5 times.
```



- **Related commands**
set_ref_coord()/amove_periodic()

8.24 amovej

▪ Features

The asynchronous movej motion operates in the same way as movej except that it does not have the radius parameter for blending. The command is the asynchronous motion command, and the next command is executed at the same time the motion begins.

Note)

- movej(pos): The next command is executed after the robot starts from the current position and reaches (stops at) pos.
- amovej(pos): The next command is executed regardless of whether the robot starts from the current position and reaches (stops at) pos.

▪ Parameters

Parameter Name	Data Type	Default Value	Description
pos	posj	-	posj or
	list (float[6])		joint angle list
vel (v)	float	None	velocity (same to all axes) or
	list (float[6])		velocity (to an axis)
acc (a)	float	None	acceleration (same to all axes) or
	list (float[6])		acceleration (acceleration to an axis)
time (t)	float	None	Reach time [sec]
mod	int	DR_MV_MOD_ABS	Movement basis <ul style="list-style-type: none"> • DR_MV_MOD_ABS: Absolute • DR_MV_MOD_REL: Relative
ra	int	DR_MV_RA_DUPLICATE	Reactive motion mode <ul style="list-style-type: none"> • DR_MV_RA_DUPLICATE: duplicate • DR_MV_RA_OVERRIDE: override

 **Note**

- Abbreviated parameter names are supported. (v:vel, a:acc, t:time)
- `_global_velj` is applied if `vel` is `None`. (The initial value of `_global_velj` is 0.0 and can be set by `set_velj`.)
- `_global_accj` is applied if `acc` is `None`. (The initial value of `_global_accj` is 0.0 and can be set by `set_accj`.)
- If the time is specified, values are processed based on time, ignoring `vel` and `acc`.
- If the time is `None`, it is set to 0.
- Refer to the description of the `movej()` motion for the path of blending according to option `ra` and `vel/acc`.

Return

Value	Description
0	Success
Negative value	Error

Exception

Exception	Description
DR_Error (DR_ERROR_TYPE)	Parameter data type error occurred
DR_Error (DR_ERROR_VALUE)	Parameter value is invalid
DR_Error (DR_ERROR_RUNTIME)	C extension module error occurred
DR_Error (DR_ERROR_STOP)	Program terminated forcefully

▪ Example

```
#Example 1. The robot moves to q1 and stops the motion 3 seconds after it begins the
motion at q0 and then moves to q99
q0 = posj(0, 0, 90, 0, 90, 0)
amovej (q0, vel=10, acc=20)      # Moves to q0 and performs the next command
immediately after
wait(3)          # Temporarily suspends the program execution for 3 seconds (while the
motion continues).
q1 = posj(0, 0, 0, 0, 90, 0)
amovej (q1, vel=10, acc=20)
# Maintains the q0 motion (DUPLICATE blending if the ra argument is omitted) and
iterates to q1.
# Performs the next command immediately after the blending motion.
mwait(0)        # Temporarily suspends the program execution until the motion is
terminated.
q99 = posj(0, 0, 0, 0, 0, 0)
movej (q99, vel=10, acc=20)     # Joint motion to q99
```

▪ Related commands

`posj()/set_velj()/set_accj()/mwait()/movej()`

8.25 amovel

▪ Features

The asynchronous movel motion operates in the same way as movel except that it does not have the radius parameter for blending. The command is the asynchronous motion command, and the next command is executed without waiting for the motion to terminate.

Note)

- movel(pos): The next command is executed after the robot starts from the current position and reaches (stops at) pos.
- amovel(pos): The next command is executed regardless of whether the robot starts from the current position and reaches (stops at) pos.

▪ Parameters

Parameter Name	Data Type	Default Value	Description
pos	posx	-	posx or position list
	list (float[6])		
vel (v)	float	None	velocity or velocity1, velocity2
	list (float[2])		
acc (a)	float	None	acceleration or acceleration1, acceleration2
	list (float[2])		
time (t)	float	None	Reach time [sec] * If the time is specified, values are processed based on time, ignoring vel and acc.
ref	int	None	reference coordinate <ul style="list-style-type: none"> • DR_BASE : base coordinate • DR_WORLD: world coordinate • DR_TOOL : tool coordinate • user coordinate: User defined
mod	int	DR_MV_MOD_ABS	Movement basis <ul style="list-style-type: none"> • DR_MV_MOD_ABS: Absolute • DR_MV_MOD_REL: Relative
ra	int	DR_MV_RA_DUPLICATE	Reactive motion mode <ul style="list-style-type: none"> • DR_MV_RA_DUPLICATE: duplicate • DR_MV_RA_OVERRIDE: override

Note

- Abbreviated parameter names supported (v:vel, a:acc, t:time).
- `_global_velx` is applied if `vel` is `None`. (The initial value of `_global_velx` is 0.0 and can be set by `set_velx`.)
- `_global_accx` is applied if `acc` is `None`. (The initial value of `_global_accx` is 0.0 and can be set by `set_accx`.)
- If an argument is inputted to `vel` (e.g., `vel=30`), the input argument corresponds to the linear velocity of the motion while the angular velocity is determined proportionally to the linear velocity.
- If an argument is inputted to `acc` (e.g., `acc=60`), the input argument corresponds to the linear acceleration of the motion while the angular acceleration is determined proportionally to the linear acceleration.
- If the time is specified, values are processed based on time, ignoring `vel` and `acc`.
- If the time is `None`, it is set to 0.
- `_g_coord` is applied if the `ref` is `None`. (The initial value of `_g_coord` is `DR_BASE`, and it can be set by the `set_ref_coord` command.)
- **The `DR_WORLD` argument of `ref` is only available in M2.40 or later versions.**
- Refer to the description of the `movej()` motion for the path of the blending according to option `ra` and `vel/acc`.

Return

Value	Description
0	Success
Negative value	Error

Exception

Exception	Description
<code>DR_Error (DR_ERROR_TYPE)</code>	Parameter data type error occurred
<code>DR_Error (DR_ERROR_VALUE)</code>	Parameter value is invalid
<code>DR_Error (DR_ERROR_RUNTIME)</code>	C extension module error occurred
<code>DR_Error (DR_ERROR_STOP)</code>	Program terminated forcefully

Example

```
#Example 1. D-Out 2 seconds after the motion starts with x1
j0 = posj(-148,-33,-54,180,92,32)
movej(j0, v=30, a=30)
```



```
x1 = posx(784, 543, 570, 0, 180, 0)
amovel (x1, vel=100, acc=200) # Performs the next motion immediately after
beginning a motion with x1.
wait(2) # Temporarily suspends the program execution for 2
seconds (while the motion continues).
set_digital_output(1, 1) # D-Out (no. 1 channel) ON
mwait(0) # Temporarily suspends the program execution until
the motion is terminated.
```

- **Related commands**

`posx()/set_velx()/set_accx()/set_tcp()/set_ref_coord()/mwait()movel()`

8.26 amovejx

▪ Features

The asynchronous movejx motion operates in the same way as movejx except that it does not have the radius parameter for blending. The command is the asynchronous motion command, and the next command is executed without waiting for the motion to terminate.

Note)

- movejx(pos): The next command is executed after the robot starts from the current position and reaches (stops at) pos.
- amovejx(pos): The next command is executed regardless of whether the robot starts from the current position and reaches (stops at) pos.

▪ Parameters

Parameter Name	Data Type	Default Value	Description
pos	posx	-	posx or
	list (float[6])		position list
vel (v)	float	None	velocity (same to all axes) or
	list (float[6])	None	velocity (to an axis)
acc (a)	float	None	acceleration (same to all axes) or
	list (float[6])	None	acceleration (acceleration to an axis)
time (t)	float	None	Reach time [sec]
ref	int	None	reference coordinate <ul style="list-style-type: none"> • DR_BASE: base coordinate • DR_WORLD: world coordinate • DR_TOOL: tool coordinate • user coordinate: User defined
mod	int	DR_MV_MOD_ABS	Movement basis <ul style="list-style-type: none"> • DR_MV_MOD_ABS: Absolute • DR_MV_MOD_REL: Relative
ra	int	DR_MV_RA_DUPLICATE	Reactive motion mode <ul style="list-style-type: none"> • DR_MV_RA_DUPLICATE: duplicate • DR_MV_RA_OVERRIDE: override
sol	int	0	Solution space

Note

- Abbreviated parameter names are supported. (v:vel, a:acc, t:time)
- `_global_velj` is applied if `vel` is None. (The initial value of `_global_velj` is 0.0 and can be set by `set_velj`.)
- `_global_accj` is applied if `acc` is None. (The initial value of `_global_accj` is 0.0 and can be set by `set_accj`.)
- If the time is specified, values are processed based on time, ignoring `vel` and `acc`.
- If the time is None, it is set to 0.
- If the time is specified, values are processed based on time, ignoring `vel` and `acc`.
- If the time is None, it is set to 0.
- `_g_coord` is applied if the `ref` is None. The initial value of `_g_coord` is `DR_BASE`, and it can be set by the `set_ref_coord` command.
- **The `DR_WORLD` argument of `ref` is only available in M2.40 or later versions.**
- Refer to the description of the `movej()` motion for the path of the blending according to option `ra` and `vel/acc`.

Caution

The blending into current active motion is disabled in the case of input with relative motion (`mod=DR_MV_MOD_REL`), and it is recommended to blend using `movej()` or `movel()`.

Return

Value	Description
0	Success
Negative value	Error

Exception

Exception	Description
<code>DR_Error (DR_ERROR_TYPE)</code>	Parameter data type error occurred
<code>DR_Error (DR_ERROR_VALUE)</code>	Parameter value is invalid
<code>DR_Error (DR_ERROR_RUNTIME)</code>	C extension module error occurred
<code>DR_Error (DR_ERROR_STOP)</code>	Program terminated forcefully

- **Example**

```
#Example 1. D-Out 2 seconds after the joint motion starts with x1
p0 = posj(-148,-33,-54,180,92,32)
movej(p0, v=30, a=30)
x1 = posx(784, 443, 770, 0, 180, 0)
amovejx (x1, vel=100, acc=200, sol=1)    # Performs the next motion immediately after
beginning a joint motion with x1.
wait(2)                                # Temporarily suspends the program execution for 2
seconds (while the motion continues).
set_digital_output(1, 1)                # D-Out (no. 1 channel) ON
mwait(0)                                # Temporarily suspends the program execution until
the motion is terminated.
```

- **Related commands**

`posx()/set_velj()/set_accj()/get_current_posx()/mwait()/movejx()`

8.27 amovec

▪ Features

The asynchronous movec motion operates in the same way as movec except that it does not have the radius parameter for blending. The command is the asynchronous motion command, and the next command is executed without waiting for the motion to terminate.

Note)

- movec(pos1. pos2): The next command is executed after the robot starts from the current position and reaches (stops at) pos2.
- amovec(pos1. pos2): The next command is executed regardless of whether the robot starts from the current position and reaches (stops at) pos2.

▪ Parameters

Parameter Name	Data Type	Default Value	Description
pos	posx	-	posx or position list
	list (float[6])		
pos2	posx	-	posx or position list
	list (float[6])		
vel (v)	float	None	velocity or velocity1, velocity2
	list (float[2])		
acc (a)	float	None	acceleration or acceleration1, acceleration2
	list (float[2])		
time (t)	float	None	Reach time [sec]
ref	int	None	reference coordinate <ul style="list-style-type: none"> • DR_BASE: base coordinate • DR_WORLD: world coordinate • DR_TOOL: tool coordinate • user coordinate: User defined
mod	int	DR_MV_MOD_ABS	Movement basis <ul style="list-style-type: none"> • DR_MV_MOD_ABS: Absolute • DR_MV_MOD_REL: Relative
angle (an)	float	None	angle or angle1, angle2
	list (float[2])		
ra	int	DR_MV_RA_DUPLICATE	Reactive motion mode

Parameter Name	Data Type	Default Value	Description
			<ul style="list-style-type: none"> DR_MV_RA_DUPLICATE: duplicate DR_MV_RA_OVERRIDE: override

Note

- Abbreviated parameter names are supported. (v:vel, a:acc, t:time, angle:an)
- `_global_vel` is applied if `vel` is None. (The initial value of `_global_vel` is 0.0 and can be set by `set_vel`.)
- `_global_accx` is applied if `acc` is None. (The initial value of `_global_accx` is 0.0 and can be set by `set_accx`.)
- If an argument is inputted to `vel` (e.g., `vel=30`), the input argument corresponds to the linear velocity of the motion while the angular velocity is determined proportionally to the linear velocity.
- If an argument is inputted to `acc` (e.g., `acc=60`), the input argument corresponds to the linear acceleration of the motion while the angular acceleration is determined proportionally to the linear acceleration.
- If the time is specified, values are processed based on time, ignoring `vel` and `acc`.
- If the time is None, it is set to 0.
- `_g_coord` is applied if the `ref` is None. (The initial value of `_g_coord` is `DR_BASE`, and it can be set by the `set_ref_coord` command.)
- **The `DR_WORLD` argument of `ref` is only available in M2.40 or later versions.**
- If the `mod` is `DR_MV_MOD_REL`, `pos1` and `pos2` are defined in the relative coordinate system of the previous `pos`. (`pos1` is the relative coordinate from the starting point while `pos2` is the relative coordinate from `pos1`.)
- If the angle is None, it is set to 0.
- If only one angle is inputted, the total rotated angle on the circular path is applied to the angle.
- If two angle values are inputted, `angle1` refers to the total rotating angle moving at a constant velocity on the circular path while `angle2` refers to the rotating angle in the rotating section for acceleration and deceleration. Here, the robot moves on the circular path at a total movement angle of $\text{angle1} + 2 \times \text{angle2}$.
- Refer to the description of the `movej()` motion for the path of the blending according to option `ra` and `vel/acc`.

Return

Value	Description
0	Success
Negative value	Error



▪ Exception

Exception	Description
DR_Error (DR_ERROR_TYPE)	Parameter data type error occurred
DR_Error (DR_ERROR_VALUE)	Parameter value is invalid
DR_Error (DR_ERROR_RUNTIME)	C extension module error occurred
DR_Error (DR_ERROR_STOP)	Program terminated forcefully

▪ Example

```
#Example 1. D-Out 3 seconds after the arc motion through x1 and x2 begins
p0 = posj(-148,-33,-54,180,92,32)
movej(p0, v=30, a=30)
x1 = posx(784, 443, 770, 0, 180, 0)
amovejx (x1, vel=100, acc=200, sol=2) # Performs the next motion immediately after
beginning a joint motion with x1.
wait(2) # Temporarily suspends the program execution for 2 seconds (while the
motion continues).
set_digital_output(1, 1) # D-Out (no. 1 channel) ON
mwait(0)
```

▪ Related commands

`posx()/set_velx()/set_accx()/set_tcp()/set_ref_coord()/mwait()/movec()`

8.28 amovesj

▪ Features

The asynchronous `movesj` motion operates in the same way as `movesj()` except for the asynchronous processing.

Generating a new command for the motion before the `amovesj()` motion results in an error for safety reasons. Therefore, the termination of the `amovesj()` motion must be confirmed using `mwait()` or `check_motion()` between `amovesj()` and the following motion command.

Note)

- `movesj(pos_list)`: The next command is executed after the robot starts from the current position and reaches (stops at) the end point of `pos_list`.
- `amovesj(pos_list)`: The next command is executed regardless of whether the robot starts from the current position and reaches (stops at) the end point of `pos_list`.

▪ Parameters

Parameter Name	Data Type	Default Value	Description
<code>pos_list</code>	list (posj)	-	posj list
<code>vel (v)</code>	float	None	velocity (same to all axes) or velocity (to an axis)
	list (float[6])		
<code>acc (a)</code>	float	None	acceleration (same to all axes) or acceleration (acceleration to an axis)
	list (float[6])		
<code>time (t)</code>	float	None	Reach time [sec]
<code>mod</code>	int	DR_MV_MOD_ABS	Movement basis <ul style="list-style-type: none"> • DR_MV_MOD_ABS: Absolute • DR_MV_MOD_REL: Relative

Note

- Abbreviated parameter names are supported. (v:vel, a:acc, t:time)
- `_global_velj` is applied if `vel` is None. (The initial value of `_global_velj` is 0.0 and can be set by `set_velj`.)
- `_global_accj` is applied if `acc` is None. (The initial value of `_global_accj` is 0.0 and can be set by `set_accj`.)
- If the time is specified, values are processed based on time, ignoring `vel` and `acc`.
- If the time is None, it is set to 0.
- If the `mod` is `DR_MV_MOD_REL`, each `pos` in the `pos_list` is defined in the relative coordinate of the previous `pos`. (If `pos_list`=[q1, q2, ...,q(n-1), q(n)], q1 is the relative angle of the starting point while q(n) is the relative coordinate of q(n-1).)
- This function does not support online blending of previous and subsequent motions.

▪ Return

Value	Description
0	Success
Negative value	Error

▪ Exception

Exception	Description
DR_Error (DR_ERROR_TYPE)	Parameter data type error occurred
DR_Error (DR_ERROR_VALUE)	Parameter value is invalid
DR_Error (DR_ERROR_RUNTIME)	C extension module error occurred
DR_Error (DR_ERROR_STOP)	Program terminated forcefully

▪ Example

```
#Example 1. D-Out 3 seconds after the spline motion through q1 - q5 begins
q0 = posj(0,0,0,0,0,0)
movej(q0, vel=30, acc=60) # Moves in joint motion to the initial position (q0).
q1 = posj(10, -10, 20, -30, 10, 20) # Defines the posj variable (joint angle) q1.
q2 = posj(25, 0, 10, -50, 20, 40)
q3 = posj(50, 50, 50, 50, 50, 50)
q4 = posj(30, 10, 30, -20, 10, 60)
q5 = posj(20, 20, 40, 20, 0, 90)

qlist = [q1, q2, q3, q4, q5]
# Defines the list (qlist) which is a set of waypoints q1-q5.

amovesj(qlist, vel=30, acc=100)
# Moves the spline curve that connects the waypoints defined in the qlist.
# with a maximum velocity of 30(mm/sec) and maximum acceleration of
100(mm/sec2).
# Executes the next command.

wait(3) # Temporarily suspends the program
execution for 3 seconds (while the motion continues).
set_digital_output(1, 1) # D-Out (no. 1 channel) ON
mwait(0) # Temporarily suspends the program execution until
the motion is terminated.
```

▪ Related commands

posj()/set_velj()/set_accj()/mwait()/amovesj()



8.29 amovesx

▪ Features

The asynchronous movesx motion operates in the same way as movesx() except for the asynchronous processing.

Generating a new command for the motion before the amovesj() motion results in an error for safety reasons. Therefore, the termination of the amovesx() motion must be confirmed using mwait() or check_motion() between amovesx() and the following motion command.

Note)

- movesx(pos_list): The next command is executed after the robot starts from the current position and reaches (stops at) the end point of pos_list.
- amovesx(pos_list): The next command is executed regardless of whether the robot starts from the current position and reaches (stops at) the end point of pos_list.

▪ Parameters

Parameter Name	Data Type	Default Value	Description
pos_list	list (posx)	-	posx list
vel (v)	float	None	velocity or velocity1, velocity2
	list (float[2])		
acc (a)	float	None	acceleration or acceleration1, acceleration2
	list (float[2])		
time (t)	float	None	Reach time [sec]
ref	int	None	reference coordinate <ul style="list-style-type: none"> • DR_BASE: base coordinate • DR_WORLD: world coordinate • DR_TOOL: tool coordinate • user coordinate: User defined
mod	int	DR_MV_MOD_ABS	Movement basis <ul style="list-style-type: none"> • DR_MV_MOD_ABS: Absolute • DR_MV_MOD_REL: Relative
vel_opt	int	DR_MVS_VEL_NONE	Velocity option <ul style="list-style-type: none"> • DR_MVS_VEL_NONE: None • DR_MVS_VEL_CONST: Constant velocity

Note

- Abbreviated parameter names are supported. (v:vel, a:acc, t:time)
- `_global_vel` is applied if `vel` is None. (The initial value of `_global_vel` is 0.0 and can be set by `set_velx`.)
- `_global_accx` is applied if `acc` is None. (The initial value of `_global_accx` is 0.0 and can be set by `set_accx`.)
- If an argument is inputted to `vel` (e.g., `vel=30`), the input argument corresponds to the linear velocity of the motion while the angular velocity is determined proportionally to the linear velocity.
- If an argument is inputted to `acc` (e.g., `acc=60`), the input argument corresponds to the linear acceleration of the motion while the angular acceleration is determined proportionally to the linear acceleration.
- If the time is specified, values are processed based on time, ignoring `vel` and `acc`.
- If the time is None, it is set to 0.
- `_g_coord` is applied if the `ref` is None. (The initial value of `_g_coord` is `DR_BASE`, and it can be set by the `set_ref_coord` command.)
- **The `DR_WORLD` argument of `ref` is only available in M2.40 or later versions.**
- If the `mod` is `DR_MV_MOD_REL`, each `pos` in the `pos_list` is defined in the relative coordinate of the previous `pos`. (If `pos_list=[p1, p2, ..., p(n-1), p(n)]`, `p1` is the relative angle of the starting point while `p(n)` is the relative coordinate of `p(n-1)`.)
- This function does not support online blending of previous and subsequent motions.

Caution

The constant velocity motion according to the distance and velocity between the waypoints cannot be used if the “`vel_opt= DR_MVS_VEL_CONST`” option (constant velocity option) is selected, and the motion is automatically switched to the variable velocity motion (`vel_opt= DR_MVS_VEL_NONE`) in that case.

Return

Value	Description
0	Success
Negative value	Error

Exception

Exception	Description
<code>DR_Error (DR_ERROR_TYPE)</code>	Parameter data type error occurred
<code>DR_Error (DR_ERROR_VALUE)</code>	Parameter value is invalid
<code>DR_Error (DR_ERROR_RUNTIME)</code>	C extension module error occurred



Exception	Description
DR_Error (DR_ERROR_STOP)	Program terminated forcefully

▪ Example

```
#Example 1. D-Out 3 seconds after the spline motion through x1 - x6 begins
P0 = posj(0,0,90,0,90,0)
movej(P0)
x0 = posx(600, 43, 500, 0, 180, 0)      # Defines the posx variable (space
coordinate/pose) x0.
movel(x0, vel=100, acc=200)  # Linear movement to the initial position x0
x1 = posx(600, 600, 600, 0, 175, 0)    # Defines the posx variable (space
coordinate/pose) x1.
x2 = posx(600, 750, 600, 0, 175, 0)
x3 = posx(150, 600, 450, 0, 175, 0)
x4 = posx(-300, 300, 300, 0, 175, 0)
x5 = posx(-200, 700, 500, 0, 175, 0)
x6 = posx(600, 600, 400, 0, 175, 0)

xlist = [x1, x2, x3, x5, x6]          # Defines the list (xlist) which is a set of x1-x6 as the
waypoints.

amovesx(xlist, vel=[100, 30], acc=[200, 60], vel_opt=DR_MVS_VEL_NONE)
    # Moves the spline curve that connects the waypoints defined in the xlist
    # with a maximum velocity of 100, 30(mm/sec, deg/sec) and maximum
acceleration of 200(mm/sec2) and
    # 60(deg/sec2). The next command is executed immediately after the motion
starts.
wait(3)      # Temporarily suspends the program execution for 3 seconds (while the
motion continues).
set_digital_output(1, 1)      # D-Out (no. 1 channel) ON
mwait(0)      # Temporarily suspends the program execution until
the motion is terminated.
```

▪ Related commands

posx()/set_vel()/set_accx()/set_tcp()/set_ref_coord()/mwait()/movesx()

8.30 amoveb

▪ Features

The asynchronous `moveb` motion operates in the same way as `moveb()` except for the asynchronous processing and executes the next line after the command is executed.

Generating a new command for the motion before the `amoveb()` motion results in an error for safety reasons. Therefore, the termination of the `amoveb()` motion must be confirmed using `mwait()` or `check_motion()` between `amoveb()` and the following motion command.

Note)

- `moveb(seg_list)`: The next command is executed after the robot starts from the current position and reaches (stops at) the end point of `seg_list`.
- `amoveb(seg_list)`: The next command is executed regardless of whether the robot starts from the current position and reaches (stops at) the end point of `seg_list`.

▪ Parameters

Parameter Name	Data Type	Default Value	Description
<code>pos_list</code>	list (posb)	-	posb list
<code>vel (v)</code>	float	None	velocity or velocity1, velocity2
	list (float[2])		
<code>acc (a)</code>	float	None	acceleration or acceleration1, acceleration2
	list (float[2])		
<code>time (t)</code>	float	None	Reach time [sec] * If the time is specified, values are processed based on time, ignoring vel and acc.
<code>ref</code>	int	None	reference coordinate <ul style="list-style-type: none"> • <code>DR_BASE</code>: base coordinate • <code>DR_WORLD</code>: world coordinate • <code>DR_TOOL</code>: tool coordinate • user coordinate: User defined
<code>mod</code>	int	<code>DR_MV_MOD_ABS</code>	Movement basis <ul style="list-style-type: none"> • <code>DR_MV_MOD_ABS</code>: Absolute • <code>DR_MV_MOD_REL</code>: Relative

Note

- Abbreviated parameter names are supported. (v:vel, a:acc, t:time)
- Up to 50 arguments can be entered in posb_list.
- `_global_velx` is applied if `vel` is None. (The initial value of `_global_velx` is 0.0 and can be set by `set_velx`.)
- `_global_accj` is applied if `acc` is None. (The initial value of `_global_accx` is 0.0 and can be set by `set_accx`.)
- If an argument is inputted to `vel` (e.g., `vel=30`), the input argument corresponds to the linear velocity of the motion while the angular velocity is determined proportionally to the linear velocity.
- If an argument is inputted to `acc` (e.g., `acc=60`), the input argument corresponds to the linear acceleration of the motion while the angular acceleration is determined proportionally to the linear acceleration.
- If the time is specified, values are processed based on time, ignoring `vel` and `acc`.
- If the time is None, it is set to 0.
- `_g_coord` is applied if the `ref` is None. (The initial value of `_g_coord` is `DR_BASE`, and it can be set by the `set_ref_coord` command.)
- **The `DR_WORLD` argument of `ref` is only available in M2.40 or later versions.**
- If the `mod` is `DR_MV_MOD_REL`, each `pos` in the `pos_list` is defined in the relative coordinate of the previous `pos`.
- This function does not support online blending of previous and subsequent motions.

Caution

- A user input error is generated if the blending radius in `posb` is 0.
- A user input error is generated due to the duplicated input of Line if contiguous Line-Line segments have the same direction.
- A user input error is generated to prevent a sudden acceleration if the blending condition causes a rapid change in direction.
- This function does not support online blending of previous and subsequent motions.

Return

Value	Description
0	Success
Negative value	Error

Exception

Exception	Description
<code>DR_Error (DR_ERROR_TYPE)</code>	Parameter data type error occurred

Exception	Description
DR_Error (DR_ERROR_VALUE)	Parameter value is invalid
DR_Error (DR_ERROR_RUNTIME)	C extension module error occurred
DR_Error (DR_ERROR_STOP)	Program terminated forcefully

Example

```

#Example 1. D-Out 3 seconds after the motion through the path of seg11 - seg16
begins
# Init Pose @ Jx1
Jx1 = posj(45,0,90,0,90,45)           # initial joint position
X0 = posx(370, 420, 650, 0, 180, 0)   # initial task position

# CASE#1) ABSOLUTE
# Absolute Goal Poses
X1 = posx(370, 670, 650, 0, 180, 0)
X1a = posx(370, 670, 400, 0, 180, 0)
X1a2 = posx(370, 545, 400, 0, 180, 0)
X1b = posx(370, 595, 400, 0, 180, 0)
X1b2 = posx(370, 670, 400, 0, 180, 0)
X1c = posx(370, 420, 150, 0, 180, 0)
X1c2 = posx(370, 545, 150, 0, 180, 0)
X1d = posx(370, 670, 275, 0, 180, 0)
X1d2 = posx(370, 795, 150, 0, 180, 0)

seg11 = posb(DR_LINE, X1, radius=20)
seg12 = posb(DR_CIRCLE, X1a, X1a2, radius=20)
seg14 = posb(DR_LINE, X1b2, radius=20)
seg15 = posb(DR_CIRCLE, X1c, X1c2, radius=20)
seg16 = posb(DR_CIRCLE, X1d, X1d2, radius=20)
b_list1 = [seg11, seg12, seg14, seg15, seg16]
# The blending radius of the last waypoint (seg16) is ignored.
movej(Jx1, vel=30, acc=60, mod=DR_MV_MOD_ABS)
# Joint motion to the initial angle (Jx1)
movel(X0, vel=150, acc=250, ref=DR_BASE, mod=DR_MV_MOD_ABS)
# Line motion to the initial position (X0)
amoveb(b_list1, vel=150, acc=250, ref=DR_BASE, mod=DR_MV_MOD_ABS)
# Moves the robot from the current position through a trajectory consisting of
seg11(LINE), seg12(CIRCLE), seg14(LINE),
# seg15(CIRCLE), and seg16(CIRCLE) with a constant velocity of 150(mm/sec)
with the exception of accelerating and decelerating sections.
# (The final point is X1d2.)
# Blending to the next segment begins when the distance of 20mm from the end
point (X1, X1a2, X1b2, X1c2, and X1d2)
# of each segment is reached.

wait(3)                               # Temporarily suspends the program
execution for 3 seconds (while the motion continues).
set_digital_output(1, 1)               # D-Out (no. 1 channel) ON

```



`mwait(0)`
the motion is terminated.

Temporarily suspends the program execution until

- **Related commands**

`posb()/set_velx()/set_accx()/set_tcp()/set_ref_coord()/mwait()/moveb()`

8.31 amove_spiral

▪ Features

The asynchronous move_spiral motion operates in the same way as move_spiral() except for the asynchronous processing and executes the next line after the command is executed.

Generating a new command for the motion before the amove_spiral() motion results in an error for safety reasons. Therefore, the termination of the amove_spiral() motion must be confirmed using mwait() or check_motion() between amove_spiral() and the following motion command.

The radius increases in a radial direction and the robot moves in parallel with the rotating spiral motion in an axial direction. It moves the robot along the spiral trajectory on the surface that is perpendicular to the axis on the coordinate specified as ref and the linear trajectory in the axis direction.

Note)

- move_spiral: The next command is executed after the robot starts from the current position and reaches (stops at) the end point of the spiral trajectory.
- amove_spiral: The next command is executed after the robot starts from the current position and regardless of whether it reaches (stops at) the end point of the spiral trajectory.

▪ Parameters

Parameter Name	Data Type	Default Value	Range	Description
rev	float	10	rev > 0	Total number of revolutions
rmax	float	10	rmax > 0	Final spiral radius [mm]
lmax	float	0		Distance moved in the axis direction [mm]
vel (v)	float	None		velocity
acc (a)	float	None		acceleration
time (t)	float	None	time ≥ 0	Total execution time <sec>
axis	int	DR_AXIS_Z	-	axis <ul style="list-style-type: none"> • DR_AXIS_X: x-axis • DR_AXIS_Y: y-axis • DR_AXIS_Z: z-axis
ref	Int	DR_TOOL	-	reference coordinate <ul style="list-style-type: none"> • DR_BASE : base coordinate • DR_WORLD: world coordinate • DR_TOOL : tool coordinate • user coordinate: user defined

Note

- Abbreviated parameter names are supported. (v:vel, a:acc, t:time)
- rev refers to the total number of revolutions of the spiral motion.
- Rmax refers to the maximum radius of the spiral motion.
- Lmax refers to the parallel distance in the axis direction during the motion. A negative value means the parallel distance in the -axis direction.
- Vel refers to the moving velocity of the spiral motion.
- The first value of `_global_velx` (parallel velocity) is applied if `vel` is None. (The initial value of `_global_velx` is 0.0 and can be set by `set_velx`.)
- Acc refers to the moving acceleration of the spiral motion.
- The first value of `_global_accx` (parallel acceleration) is applied if `acc` is None. (The initial value of `_global_accx` is 0.0 and can be set by `set_accx`.)
- If the time is specified, values are processed based on time, ignoring `vel` and `acc`.
- If the time is None, it is set to 0.
- The axis defines the axis that is perpendicular to the surface defined by the spiral motion.
- Ref refers to the reference coordinate system defined by the spiral motion.
- **The DR_WORLD argument of ref is only available in M2.40 or later versions.**
- This function does not support online blending of previous and subsequent motions.

Caution

- An error can be generated to ensure safe motion if the rotating acceleration calculated by the spiral path is too great.
In this case, reduce the `vel`, `acc`, or time value.

Return

Value	Description
0	Success
Negative value	Error

Exception

Exception	Description
DR_Error (DR_ERROR_TYPE)	Parameter data type error occurred
DR_Error (DR_ERROR_VALUE)	Parameter value is invalid
DR_Error (DR_ERROR_RUNTIME)	C extension module error occurred
DR_Error (DR_ERROR_STOP)	Program terminated forcefully

▪ Example

```

## hole search
# (A motion that completes 9.5 revolutions (rev) to the 30 mm radius (rmax) from 0 on
# the Tool-X/Y surface as the center of the rotation in the Tool-Z direction
# and the spiral trajectory that moves 50 mm (lmax) in the Tool-Z direction at the same
# time in 20 seconds
# from the initial position.
# D-Out (no. 1 channel) 3 seconds after the motion begins.)

J00 = posj(0,0,90,0,60,0)
moveJ(J00, vel=30, acc=30)      # Joint moves to the beginning pose
amove_spiral(rev=9.5,rmax=50.0,lmax=50.0,time=10.0,axis=DR_AXIS_Z,ref=DR_TOO
L)
wait(3)
set_digital_output(1, 1)      # D-Out (no. 1 channel) ON
mwait(0)                      # Waits until the motion stops.

```

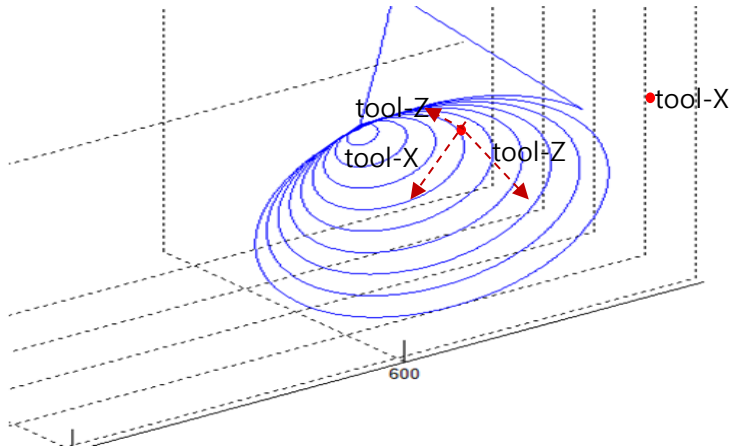

▪ Related commands

set_velx()/set_accx()/set_tcp()/set_ref_coord()/mwait()/move_spiral()

8.32 amove_periodic

▪ Features

The asynchronous move_periodic motion operates in the same way as move_periodic() except for the asynchronous processing and executes the next line after the command is executed.

Generating a new command for the motion before the amove_periodic() motion results in an error for safety reasons. Therefore, the termination of the amove_periodic() motion must be confirmed using mwait() or check_motion() between amove_periodic() and the following motion command.

This command performs a cyclic motion based on the sine function of each axis (parallel and rotation) of the reference coordinate (ref) input as a relative motion that begins at the current position. The attributes of the motion on each axis are determined by amp (amplitude) and period, and the acceleration/deceleration time and the total motion time are set by the interval and repetition count.

Note)

- move_periodic: The next command is executed after the robot starts from the current position and reaches (stops at) the end point of the periodic trajectory.
- amove_periodic: The next command is executed after the robot starts from the current position and regardless of whether it reaches (stops at) the end point of the periodic trajectory.

▪ Parameters

Parameter Name	Data Type	Default Value	Range	Description
amp	list (float[6])	-	$0 \leq \text{amp}$	Amplitude (motion between -amp and +amp) [mm] or [deg]
period	float or list (float[6])		$0 \leq \text{period}$	Period (time for 1 cycle) [sec]
atime	float	0.0	$0 \leq \text{atime}$	Acc-, dec- time [sec]
repeat	int	1	> 0	Repetition count
ref	int	DR_TOOL	-	reference coordinate <ul style="list-style-type: none"> • DR_BASE : base coordinate • DR_WORLD: world coordinate • DR_TOOL : tool coordinate • user coordinate: user defined

Note

- Amp refers to the amplitude. The input is a list of 6 elements which are the amp values for the axes (x, y, z, rx, ry, and rz). The amp input on the axis that does not have a motion must be 0.
- Period refers to the time needed to complete a motion in the direction, the amplitude. The input is a list of 6 elements which are the periods for the axes (x, y, z, rx, ry, and rz).
- Atime refers to the acceleration and deceleration time at the beginning and end of the periodic motion. The largest of the inputted acceleration/deceleration times and maximum period*1/4 is applied. An error is generated when the inputted acceleration/deceleration time exceeds 1/2 of the total motion time.
- Repeat refers to the number of repetitions of the axis (reference axis) that has the largest period value and determines the total motion time. The number of repetitions for each of the remaining axes is determined automatically according to the motion time.
- If the motion terminates normally, the motions for the remaining axes can be terminated before the reference axis's motion terminates so that the end position matches the starting position. The deceleration section will deviate from the previous path if the motions of all axes are not terminated at the same time. Refer to the following image for more information.

CASE-1) All-axis motions end at the same time

`move_periodic(amp=[100,100,0,0,0,0], period=[3.2,1.6,0,0,0,0], atime=3.1, repeat=2, ref=DR_BASE)`

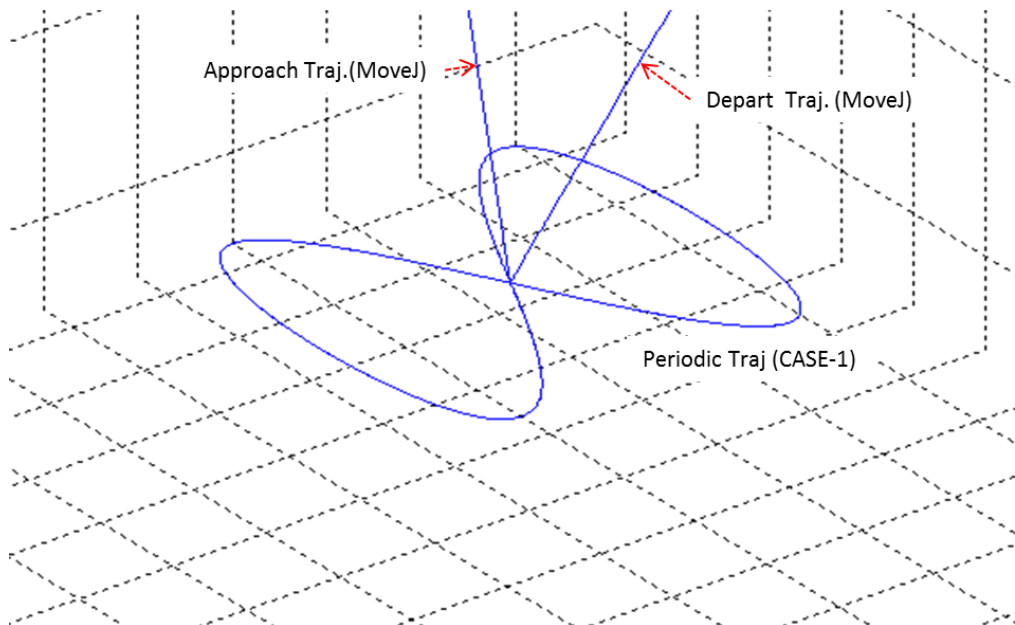

- Ref refers to the reference coordinate system of the repeated motion.
- **The DR_WORLD argument of ref is only available in M2.40 or later versions.**
- If a maximum velocity error is generated during a motion, adjust the amplification and period using the following formula.

Max. velocity = Amplification(amp)*2*pi(3.14)/Period(period) (i.e., Max. velocity=62.83mm/sec if amp=10mm and period=1 sec)

- This function does not support online blending of previous and subsequent motions.

Return

Value	Description
0	Success
Negative value	Error

Exception

Exception	Description
DR_Error (DR_ERROR_TYPE)	Parameter data type error occurred
DR_Error (DR_ERROR_VALUE)	Parameter value is invalid
DR_Error (DR_ERROR_RUNTIME)	C extension module error occurred
DR_Error (DR_ERROR_STOP)	Program terminated forcefully

Example

```
P0 = posj(0,0,90,0,90,0)
movej(P0)
amove_periodic(amp =[10,0,0,0,0.5,0], period=1, atime=0.5, repeat=5, ref=DR_TOOL)
wait(1)
set_digital_output(1, 1)
mwait(0)
# Repeats the x-axis (10mm amp and 1 sec. period) motion and y rotating axis (0.5deg
amp and 1 sec. period) motion in the tool coordinate system
# 5 times.
# SET(1) the Digital_Output channel no. 1, 1 second after the periodic motion begins.
```

Related commands

`set_ref_coord()/move_periodic()`

8.33 mwait(time=0)

▪ Features

This function sets the waiting time between the previous motion command and the motion command in the next line. The waiting time differs according to the time[sec] input.

▪ Parameters

Parameter Name	Data Type	Default Value	Description
time	float	0	Waiting time after the motion ends [sec]

▪ Return

Value	Description
0	Success
Negative value	Error

▪ Exception

Exception	Description
DR_Error (DR_ERROR_TYPE)	Parameter data type error occurred
DR_Error (DR_ERROR_VALUE)	Parameter value is invalid
DR_Error (DR_ERROR_RUNTIME)	C extension module error occurred
DR_Error (DR_ERROR_STOP)	Program terminated forcefully



▪ Example

```
#Example 1. The robot moves to q1 and stops the motion 3 seconds after it begins the
motion at q0 and then moves to q99
q0 = posj(0, 0, 90, 0, 90, 0)
amovej (q0, vel=10, acc=20)      # Moves to q0 and performs the next command
immediately after
wait(3)                          # Temporarily suspends the program
execution for 3 seconds (while the motion continues).
q1 = posj(0, 0, 0, 0, 90, 0)
amovej (q1, vel=10, acc=20)
    # Maintains the q0 motion (DUPLICATE blending if the ra argument is omitted)
    and iterates to q1.
    # Performs the next command immediately after the blending motion.
mwait(0)                          # Temporarily suspends the program execution until
the motion is terminated.
q99 = posj(0, 0, 0, 0, 0, 0)
movej (q99, vel=10, acc=20)      # Joint motion to q99.
```

▪ Related commands

```
wait()/amovej()/amovel()/amovejx()/amovec()/amovesj()/amovesx()/amoveb()/
amove_spiral()/amove_periodic()
```

8.34 check_motion()

▪ Features

This function checks the status of the currently active motion.

▪ Parameters

Not applicable

▪ Return (TBD)

Value	Description
0	DR_STATE_IDLE (no motion in action)
1	DR_STATE_INIT (motion being calculated)
2	DR_STATE_BUSY (motion in operation)

▪ Exception

Exception	Description
DR_Error (DR_ERROR_RUNTIME)	C extension module error occurred
DR_Error (DR_ERROR_STOP)	Program terminated forcefully

▪ Example

```
#1. The next motion (q99) is executed when an asynchronous motion to q0 begins
decelerating
q0 = posj(0, 0, 90, 0, 90, 0)
q99 = posj(0, 0, 0, 0, 0, 0)
amovej (q0, vel=10, acc=20)      # Executes the next command immediately after the
motion to q0.
while True:
    if check_motion()==0:        # A motion is completed.
        amovej (q99, vel=10, acc=20) # Joint motion to q99.
        break
    if check_motion()==2:        # In motion
        pass
mwait(0)                         # Temporarily suspends the program execution until
the motion is terminated.
```

▪ Related commands

[movej\(\)](#)/[movel\(\)](#)/[movejx\(\)](#)/[movec\(\)](#)/[movesj\(\)](#)/[movesx\(\)](#)/[moveb\(\)](#)/[move_spiral\(\)](#)
[/move_periodic\(\)](#)/[amovej\(\)](#)/[amovl\(\)](#)/[amovejx\(\)](#)/[amovec\(\)](#)/[amovesj\(\)](#)/[amovesx\(\)](#)/[amoveb\(\)](#)
[\(\)/a](#)[move_spiral\(\)](#)/[amove_periodic\(\)](#)

8.35 stop(st_mode)

▪ Features

This function stops the currently active motion. This function stops differently according to the st_mode received as an argument. All stop modes except Estop stop the motion in the currently active section.

▪ Parameters

Parameter Name	Data Type	Default Value	Description
st_mode	int	-	stop mode <ul style="list-style-type: none"> • DR_QSTOP_STO: Stop Category 1 • DR_QSTOP: Stop Category 2 • DR_SSTO: Stop Category 2 • DR_HOLD: emergency stop

▪ Return

Value	Description
0	Success
Negative value	Error

▪ Exception

Exception	Description
DR_Error (DR_ERROR_TYPE)	Parameter data type error occurred
DR_Error (DR_ERROR_VALUE)	Parameter value is invalid
DR_Error (DR_ERROR_RUNTIME)	C extension module error occurred
DR_Error (DR_ERROR_STOP)	Program terminated forcefully

- **Example**

```
#1. The motion is terminated with a soft stop 2 seconds after moving to x1
p0 = posj(-148,-33,-54,180,92,32)
movej(p0, v=30, a=30)
x1 = posx(784, 543, 570, 0, 180, 0)
amovel (x1, vel=100, acc=200) # Executes the next command immediately after the
motion with x1.
wait(2) # Temporarily suspends the program for 2 seconds.
stop(DR_SSTOP) # Stops the motion with a soft stop.
```

- **Related commands**

```
movej()/movel()/movejx()/movec()/movesj()/movesx()/moveb()/move_spiral()
/move_periodic()/amovej()/amovel()/amovejx()/amovec()/amovesj()/amovesx()/moveb
()/amove_spiral()/amove_periodic()
```

8.36 change_operation_speed(speed)

▪ Features

This function adjusts the operation velocity. The argument is the relative velocity in a percentage of the currently set velocity and has a value from 1 to 100. Therefore, a value of 50 means that the velocity is reduced to 50% of the currently set velocity.

▪ Parameters

Parameter Name	Data Type	Default Value	Description
speed	int	-	operation speed(1~100)

▪ Return

Value	Description
0	Success
Negative value	Error

▪ Exception

Exception	Description
DR_Error (DR_ERROR_TYPE)	Parameter data type error occurred
DR_Error (DR_ERROR_VALUE)	Parameter value is invalid
DR_Error (DR_ERROR_RUNTIME)	C extension module error occurred
DR_Error (DR_ERROR_STOP)	Program terminated forcefully

▪ Example

```
change_operation_speed(10)
change_operation_speed(100)
#1. Motion with velocity specified to q0 and 20% of the specified velocity
q0 = posj(0, 0, 90, 0, 90, 0)
movej (q0, vel=10, acc=20)      # Moves to q0 at a velocity of 10mm/sec
change_operation_velocity(10)  # The velocities of all following motions executed are
10% of the specified velocity.
q1 = posj(0, 0, 0, 0, 90, 0)
movej (q1, vel=10, acc=20)      # Moves to q1 at a velocity of 10% of 10mm/sec.
change_operation_speed(100)    # The velocities of all following motions executed are
100% of the specified velocity.
movej (q0, vel=10, acc=20)      # Moves to q0 at a velocity 100% of 10mm/sec
```

▪ Related commands

`movej()/movei()/movejx()/movec()/movesj()/movesx()/moveb()/move_spiral()/move_pe
riodic()/amovej()/amovei()/amovejx()/amovec()/amovesj()/amovesx()/amoveb()/amove_
spiral()/amove_periodic()`

8.37 enable_alter_motion(n, mode, ref, limit_dPOS, limit_dPOS_per)

Features

This function is only available for M2.40 or later versions.

enable_alter_motion() and alter_motion() functions enable to alter motion trajectory. This function sets the configurations for altering function and allows the input quantity of alter_motion() to be applied to motion trajectory. The unit cycle time of generating alter motion is 100msec. Cycle time($n \times 100\text{msec}$) can be changed through input parameter n. This function provide 2 modes(Accumulation mode, Increment mode). Input quantity of alter_motion() can be applied to motion trajectory in two ways as accumulated value or increment value. In accumulation mode, the input quantity means absolute altering amount(dX,dY,dZ,dRX,dRY,dRZ) from current motion trajectory. On the contrary in increment mode, the quantity means increment value from the previous absolute altering amount. The reference coordinate can be changed through input parameter ref. Limitations of accumulation amount and increment amount can be set through input parameter limit_dPOS (accumulated limit) and limit_dPOS_per(increment input limit during 1 cycle). The actual alter amount is limited to these limits.

Parameters

Parameter Name	Data Type	Default Value	Description
n	int	None	Cycle time number
mode	Int	None	Mode <ul style="list-style-type: none"> DR_DPOS : accumulation amount DR_VEL : increment amount
ref	int	None	reference coordinate <ul style="list-style-type: none"> DR_BASE : base coordinate DR_WORLD : world coordinate DR_TOOL : tool coordinate user coordinate: user defined
limit_dPOS	list(float[2])	None	First value : limitation of position[mm] Second value : limitation of orientation[deg]
Limit_dPOS_per	list(float[2])	None	Fist value : limitation of position[mm] Second value : limitation of orientation[deg]

Note

- _global_ref is applied if ref is None

- Accumulation amount or increment amount isn't be limited if limit_dPOS or limit_dPOS_per is None.
- alter_motion() can be executed only in user thread.

Return

Value	Description
0	Success
Negative value	Error

Exception

Exception	Description
DR_Error (DR_ERROR_TYPE)	Parameter data type error occurred
DR_Error (DR_ERROR_VALUE)	Parameter value is invalid
DR_Error (DR_ERROR_RUNTIME)	C extension module error occurred
DR_Error (DR_ERROR_STOP)	Program terminated forcefully

Example

```
def alter_thread():
    alter_motion(dX) #dX : amount of alter motion

dX = [10,0,0,10,0,0]

J00 = posj(0,0,90,0,90)
X1 = posx(559.0, 200, 651.5, 180, -180.0, 180)
X2 = posx(559.0, 200, 400, 180, -180.0, 180)

movej(J00,vel=50,acc=100)

enable_alter_motion(n=10,mode=DR_DPOS, ref=DR_BASE, limit_dPOS=[50,90],
limit_dPOS_per=[50,50])
# cycle time:(5*100)msec, mode:accumulate, reference coordination:base
coordination
# Lmitation of accumulation amount :50mm,50deg
```



```
# Limitation of increment amount :10mm, 10deg

th_id = thread_run(alter_thread, loop=True)

movel(X1,v=50,a=100,r=30)
movel(X2,v=50,a=100)

thread_stop(th_id)
disable_alter_motion() # deactivates alter motion
```

- **Related commands**

alter_motion(pos), disable_alter_motion()

8.38 Alter_motion([x,y,z,rx,ry,rz])

Features

This function is only available for M2.40 or later versions.

This function applies altering amount of motion trajectory when the alter function is activated. The meaning of the input values is defined from enable_alter_motion().

Caution

- alter_motion() can be executed only in user thread.

Note

- alter_motion() can be executed only in user thread.
- Alter motion can be adjusted through setting value limit_dPOS or limit_dPOS_per in enable_alter_motion function.
- Orientation of Input pose follows fixed XYZ notation.

Parameters

Parameter Name	Data Type	Default Value	Description
pos	list (float[6])	None	position list

Return

Value	Description
0	Success
Negative value	Error

Exception

Exception	Description
DR_Error (DR_ERROR_TYPE)	Parameter data type error occurred
DR_Error (DR_ERROR_VALUE)	Parameter value is invalid
DR_Error (DR_ERROR_RUNTIME)	C extension module error occurred
DR_Error (DR_ERROR_STOP)	Program terminated forcefully

▪ Example

```
def alter_thread():
    alter_motion(dX) #dX : amount of alter motion

dX = [10,0,0,10,0,0]

J00 = posj(0,0,90,0,90)
X1 = posx(559.0, 200, 651.5, 180, -180.0, 180)
X2 = posx(559.0, 200, 400, 180, -180.0, 180)

movej(J00,vel=50,acc=100)

enable_alter_motion(n=5,mode=DR_DPOS, ref=DR_BASE, limit_dPOS=[50,90],
limit_dPOS_per=[10,10])
# cycle time:(5*100)msec, mode:accumulate, reference coordination:base
coordination
# Lmitation of accumulation amount :50mm,90deg
# Limitation of increment amount :10mm, 10deg

th_id = thread_run(alter_thread, loop=True)

movel(X1,v=50,a=100,r=30)
movel(X2,v=50,a=100)

thread_stop(th_id)
disable_alter_motion() # deactivates alter motion
```

▪ Related commands

enable_alter_motion(n,mode,ref,limit_dPOS,limit_dPOS_per), disable_alter_motion()

8.39 disalbe_alter_motion()

▪ Features

This function is only available for M2.40 or later versions.

This function deactivates alter motion.

▪ Return

Value	Description
0	Success
Negative value	Error

▪ Exception

Exception	Description
DR_Error (DR_ERROR_TYPE)	Parameter data type error occurred
DR_Error (DR_ERROR_VALUE)	Parameter value is invalid
DR_Error (DR_ERROR_RUNTIME)	C extension module error occurred
DR_Error (DR_ERROR_STOP)	Program terminated forcefully

▪ Example

```
def alter_thread():
    alter_motion(dX) #dX : amount of alter motion

dX = [10,0,0,10,0,0]

J00 = posj(0,0,90,0,90)
X1 = posx(559.0, 200, 651.5, 180, -180.0, 180)
X2 = posx(559.0, 200, 400, 180, -180.0, 180)

movej(J00,vel=50,acc=100)

enable_alter_motion(n=10,mode=DR_DPOS, ref=DR_BASE, limit_dPOS=[50,90],
limit_dPOS_per=[50,50])
# cycle time:(5*100)msec, mode:accumulate, reference coordination:base
```



```
coordination
# Limitation of accumulation amount :50mm,50deg
# Limitation of increment amount :10mm, 10deg

th_id = thread_run(alter_thread, loop=True)

movel(X1,v=50,a=100,r=30)
movel(X2,v=50,a=100)

thread_stop(th_id)
disable_alter_motion() # deactivates alter motion
```

- **Related commands**

```
enable_alter_motion(n,mode,ref,limit_dPOS,limit_dPOS_per), alter_motion(pos)
```

9. Auxiliary Control Functions

9.1 get_control_mode()

- **Features**

This function returns the current control mode.

- **Parameters**

Not applicable

- **Return**

Value	Description
int	Control mode 3 : Position control mode 4 : Torque control mode

- **Exception**

Exception	Description
DR_Error (DR_ERROR_RUNTIME)	C extension module error occurred

- **Example**

```
mode = get_control_mode()
```

- **Related commands**

Not applicable

9.2 get_control_space()

▪ Features

This function returns the current control space.

▪ Parameters

Not applicable

▪ Return

Value	Description
int	Control mode 1 : Joint space control 2 : Task space control

▪ Exception

Exception	Description
DR_Error (DR_ERROR_RUNTIME)	C extension module error occurred

▪ Example

```
x1 = get_control_space()
```

▪ Related commands

Not applicable

9.3 get_current_posj()

- **Features**

This function returns the current joint angle.

- **Parameters**

Not applicable

- **Return**

Value	Description
posj	Joint angle

- **Exception**

Exception	Description
DR_Error (DR_ERROR_RUNTIME)	C extension module error occurred

- **Example**

```
q1 = get_current_posj()
```



9.4 get_current_velj()

- **Features**

This function returns the current joint velocity.

- **Parameters**

Not applicable

- **Return**

Value	Description
float[6]	Joint speed

- **Exception**

Exception	Description
DR_Error (DR_ERROR_RUNTIME)	C extension module error occurred

- **Example**

```
velj1 = get_current_velj()
```

- **Related commands**

`get_desired_velj()`

9.5 get_desired_posj()

▪ Features

This function returns the current target joint angle. It cannot be used in the move!, movec, movesx, moveb, move_spiral, or move_periodic command.

▪ Parameters

Not applicable

▪ Return

Value	Description
posj	Joint angle

▪ Exception

Exception	Description
DR_Error (DR_ERROR_RUNTIME)	C extension module error occurred
DR_Error (DR_ERROR_INVALID)	Invalid command

▪ Example

```
jp1 = get_desired_posj()
```

▪ Related commands

get_current_posj()

9.6 get_desired_velj()

▪ Features

This function returns the current target joint velocity. It cannot be used in the move1, movec, movesx, moveb, move_spiral, or move_periodic command.

▪ Parameters

Not applicable

▪ Return

Value	Description
float[6]	Target joint velocity

▪ Exception

Exception	Description
DR_Error (DR_ERROR_RUNTIME)	C extension module error occurred
DR_Error (DR_ERROR_INVALID)	Invalid command

▪ Example

```
velj1 = get_desired_velj()
```

▪ Related commands

`get_current_velj()`

9.7 get_current_posx(ref)

▪ Features

This returns the pose and solution space of the current coordinate system. The pose is based on the base coordinate.

▪ Parameters

Parameter Name	Data Type	Default Value	Description
ref	Int	DR_BASE	reference coordinate <ul style="list-style-type: none"> • DR_BASE : base coordinate • DR_WORLD : world coordinate • user coordinate: User defined

Note

- The ref argument is only available in M2.40 or later versions.

▪ Return

Value	Description
Posx	Task space point
Int	Solution space (0 ~ 7)

▪ Exception

Exception	Description
DR_Error (DR_ERROR_RUNTIME)	C extension module error occurred

▪ Example

```
x1, sol = get_current_posx() #x1 w.r.t. DR_BASE
```

9.8 get_current_tool_flange_posx()

▪ Features

This function returns the pose of the current tool flange based on the ref coordinate. In other words, it means the return to tcp=(0,0,0,0,0,0).

▪ Parameters

Parameter Name	Data Type	Default Value	Description
ref	int	DR_BASE	reference coordinate <ul style="list-style-type: none"> • DR_BASE : base coordinate • DR_WORLD : world coordinate

Note

- The ref argument is only available in M2.40 or later versions.

▪ Return

Value	Description
posx	Pose of tool flange

▪ Exception

Exception	Description
DR_Error (DR_ERROR_RUNTIME)	C extension module error occurred

▪ Example

```
x1 = get_current_tool_flange_posx()
#x1 : Flange pose base on the base coordinate(default value)
x2 = get_current_tool_flange_posx(DR_BASE)
#x2 : Flange pose based on the base coordinate
x3 = get_current_tool_flange_posx(DR_WORLD)
#x3 : Flange pose based on the world coordinate
```

▪ Related commands

Not applicable



9.9 get_current_velx()

▪ Features

This function returns the current tool velocity based on the ref coordinate.

▪ Parameters

Parameter Name	Data Type	Default Value	Description
ref	Int	DR_BASE	reference coordinate • DR_BASE : base coordinate • DR_WORLD : world coordinate

Note

- The ref argument is only available in M2.40 or later versions.

▪ Return

Value	Description
float[6]	Tool velocity

▪ Exception

Exception	Description
DR_Error (DR_ERROR_RUNTIME)	C extension module error occurred

▪ Example

```

velx1 = get_current_velx()
# velx1 : velocity based on the base coordinate(default value)
velx2 = get_current_velx(DR_BASE)
# velx2 (=velx1) : velocity based on the base coordinate
velx3 = get_current_velx(DR_WORLD)
#velx3 : velocity based on the world coordinate
    
```

▪ Related commands

get_desired_velx()

9.10 get_desired_posx(ref)

Features

This function returns the target pose of the current tool. The pose is based on the ref coordinate.

Parameters

Parameter Name	Data Type	Default Value	Description
ref	Int	DR_BASE	reference coordinate <ul style="list-style-type: none"> DR_BASE : base coordinate DR_WORLD : world coordinate user coordinate: User defined

Note

- ref: DR_BASE (base coordinate)/user coordinate (globally declared user coordinate)
- DR_BASE is applied when ref is omitted.
- The DR_WORLD argument of ref is only available in M2.40 or later versions.**

Return

Value	Description
float[6]	Tool velocity

Exception

Exception	Description
DR_Error (DR_ERROR_RUNTIME)	C extension module error occurred

Example

```

x1 = get_desired_posx() #x1 w.r.t. DR_BASE
x2 = posx(100, 0, 0, 0, 0, 0)
x3 = posx(0, 0, 20, 20, 20, 20)
pos = x3
DR_USR1=set_user_cart_coord(x1, x2, x3, pos)
set_ref_coord(DR_USR1)

xa = get_desired_posx(DR_USR1) #xa w.r.t. DR_USR1

xb = get_desired_posx(DR_WORLD) #xb w.r.t. DR_WORLD
    
```

- **Related commands**

get_desired_posx()

9.11 get_desired_velx()

- **Features**

This function returns the target velocity of the current tool based on the ref coordinate. It cannot be used in the movej, movejx, or movesj command.

- **Parameters**

Parameter Name	Data Type	Default Value	Description
ref	Int	DR_BASE	reference coordinate <ul style="list-style-type: none"> • DR_BASE : base coordinate • DR_WORLD : world coordinate

 **Note**

- The ref argument is only available in M2.40 or later versions.

- **Return**

Value	Description
float[6]	Tool velocity

- **Exception**

Exception	Description
DR_Error (DR_ERROR_RUNTIME)	C extension module error occurred
DR_Error (DR_ERROR_INVALID)	Invalid command

- **Example**

```

vel_x1 = get_desired_velx()
#vel_x1 : desired velocity of the tool based on the base coordinate(default value)
vel_x2 = get_desired_velx(DR_BASE)
#vel_x2 : desired velocity of the tool based on the base coordinate
vel_x3 = get_desired_velx(DR_WORLD)
#vel_x3 : desired velocity of the tool based on the world
    
```

- **Related commands**

get_current_velx()





9.12 get_current_solution_space()

- **Features**

This function returns the current solution space value.

- **Parameters**

Not applicable

- **Return**

Value	Description
int	Solution space (0 ~ 7)

- **Exception**

Exception	Description
DR_Error (DR_ERROR_RUNTIME)	C extension module error occurred

9.13 get_current_rotm(ref)

Features

This function returns the direction and matrix of the current tool based on the ref coordinate.

Parameters

Parameter Name	Data Type	Default Value	Description
ref	Int	DR_BASE	reference coordinate <ul style="list-style-type: none"> DR_BASE : base coordinate DR_WORLD : world coordinate

Note

- The ref argument is only available in M2.40 or later versions.

Return

Value	Description
float[3][3]	Rotation matrix

Exception

Exception	Description
DR_Error (DR_ERROR_RUNTIME)	C extension module error occurred

Example

```

rotm1 = get_current_rotm(DR_WORLD)
#rotm1 : rotation matrix(3x3) based on the world coordinate
# The result value is stored in a 3x3 matrix.
rotm1 = [
    [rotm1[0][0]  rotm1[0][1]  rotm1[0][2]]
    [rotm1[1][0]  rotm1[1][1]  rotm1[1][2]]
    [rotm1[2][0]  rotm1[2][1]  rotm1[2][2]]
]
    
```

Related commands

Not applicable



9.14 get_joint_torque()

- **Features**

This function returns the sensor torque value of the current joint.

- **Parameters**

Not applicable

- **Return**

Value	Description
float[6]	JTS torque value

- **Exception**

Exception	Description
DR_Error (DR_ERROR_RUNTIME)	C extension module error occurred

- **Example**

```
j_trq1 = get_joint_torque()
```

- **Related commands**

`get_external_torque()/get_tool_force()`

9.15 get_external_torque()

▪ Features

This function returns the torque value generated by the external force on each current joint.

▪ Parameters

Not applicable

▪ Return

Value	Description
float[6]	Torque value generated by an external force

▪ Exception

Exception	Description
DR_Error (DR_ERROR_RUNTIME)	C extension module error occurred

▪ Example

```
trq_ext=get_external_torque()
```

▪ Related commands

get_joint_torque()/get_tool_force()

9.16 get_tool_force(ref)

Features

This function returns the external force applied to the current tool based on the ref coordinate. The force is based on the base coordinate while the moment is based on the tool coordinate.

Parameters

Parameter Name	Data Type	Default Value	Description
ref	Int	DR_BASE	reference coordinate <ul style="list-style-type: none"> DR_BASE : base coordinate DR_WORLD : world coordinate

Note

- The ref argument is only available in M2.40 or later versions.

Return

Value	Description
float[6]	External force applied to the tool

Exception

Exception	Description
DR_Error (DR_ERROR_RUNTIME)	C extension module error occurred

Example

```
force_ext = get_tool_force()
```

Related commands

get_joint_torque()/get_external_torque()

9.17 get_solution_space(pos)

▪ Features

This function obtains the solution space value.

▪ Parameters

Parameter Name	Data Type	Default Value	Description
pos	posj	-	posj or position list
	list (float[6])		

▪ Return

Value	Description
0 ~ 7	Solution space

▪ Exception

Exception	Description
DR_Error (DR_ERROR_TYPE)	Parameter data type error occurred
DR_Error (DR_ERROR_VALUE)	Parameter value is invalid
DR_Error (DR_ERROR_RUNTIME)	C extension module error occurred
DR_Error (DR_ERROR_STOP)	Program terminated forcefully

▪ Example

```
q1 = posj(0, 0, 0, 0, 0, 0)
sol1 = get_solution_space(q1)
sol2 = get_solution_space([10, 20, 30, 40, 50, 60])
```

▪ Related commands

get_current_solution_space()



10. Other Settings and Safety-related Functions

10.1 get_workpiece_weight()

- **Features**

This function measures and returns the weight of the workpiece.

- **Parameters**

Not applicable

- **Return**

Value	Description
Positive value	Measured weight
Negative value	Error

- **Exception**

Exception	Description
DR_Error (DR_ERROR_RUNTIME)	C extension module error occurred
DR_Error (DR_ERROR_STOP)	Program terminated forcefully

- **Example**

```
weight = get_workpiece_weight()
```

- **Related commands**

set_workpiece_weight()/reset_workpiece_weight()

10.2 reset_workpiece_weight()

▪ Features

This function initializes the weight data of the material to initialize the algorithm before measuring the weight of the material.

▪ Parameters

Not applicable

▪ Return

Value	Description
0	Success
Negative value	Error

▪ Exception

Exception	Description
DR_Error (DR_ERROR_RUNTIME)	C extension module error occurred
DR_Error (DR_ERROR_STOP)	Program terminated forcefully

▪ Example

```
reset_workpiece_weight()
```

▪ Related commands

set_workpiece_weight()/get_workpiece_weight()



10.3 set_tool(name)

▪ Features

This function retrieves the tool data registered in the Teach Pendant by name.

▪ Parameters

Parameter Name	Data Type	Default Value	Description
name	string	-	Tool name registered in the Teach Pendant

▪ Return

Value	Description
0	Success
Negative value	Error

▪ Exception

Exception	Description
DR_Error (DR_ERROR_TYPE)	Parameter data type error occurred
DR_Error (DR_ERROR_VALUE)	Parameter value is invalid
DR_Error (DR_ERROR_RUNTIME)	C extension module error occurred
DR_Error (DR_ERROR_STOP)	Program terminated forcefully

▪ Example

```
set_tool ("tool1") # Calls the "tool1" data registered in the TP and sets it as the tool.
```

▪ Related commands

set_tcp()

10.4 set_tool_shape(name)

▪ Features

This function activates the tool shape information of the entered name among the tool shape information registered in the Teach Pendant.

▪ Parameters

Parameter Name	Data Type	Default Value	Description
name	string	-	Tool name registered in the Teach Pendant

▪ Return

Value	Description
0	Success
Negative value	Error

▪ Exception

Exception	Description
DR_Error (DR_ERROR_TYPE)	Parameter data type error occurred
DR_Error (DR_ERROR_VALUE)	Parameter value is invalid
DR_Error (DR_ERROR_RUNTIME)	C extension module error occurred
DR_Error (DR_ERROR_STOP)	Program terminated forcefully

▪ Example

```
set_tool_shape("tool_shape1") # Activate the geometry of "tool_shape1".
```

▪ Related commands

set_tcp()

10.5 set_singularity_handling(mode)

Features

In case of path deviation due to the effect of singularity in task motion, user can select the response policy. The mode can be set as follows.

- Automatic avoidance mode(Default) : DR_AVOID
- Path first mode : DR_TASK_STOP
- Variable velocity mode : DR_VAR_VEL

The default setting is automatic avoidance mode, which reduces instability caused by singularity, but reduces path tracking accuracy. In case of path first setting, if there is possibility of instability due to singularity, a warning message is output after deceleration and then the corresponding task is terminated. In case of variable velocity mode setting, TCP velocity would be changed in singular region to reduce instability and maintain path tracking accuracy.

Parameters

Parameter Name	Data Type	Default Value	Description
mode	int	DR_AVOID	DR_AVOID : Automatic avoidance mode DR_TASK_STOP : Deceleration/ Warning/ Task termination DR_VAR_VEL : Variable velocity mode

Return

Value	Description
0	Success
Negative value	Error

Exception

Exception	Description
DR_Error (DR_ERROR_TYPE)	Parameter data type error occurred
DR_Error (DR_ERROR_VALUE)	Parameter value is invalid
DR_Error (DR_ERROR_RUNTIME)	C extension module error occurred
DR_Error (DR_ERROR_STOP)	Program terminated forcefully

Example

```
.P1 = posx(400,500,800,0,180,0)
P2 = posx(400,500,500,0,180,0)
```



related Functions

```
P3 = posx(400,500,200,0,180,0)
set_singularity_handling (DR_AVOID) # Automatic avoidance mode for singularity
movel(P1, vel=10, acc=20)
set_velx(30)
set_accx(60)
set_singularity_handling(DR_TASK_STOP) # Task motion path first
movel(P2)
set_singularity_handling(DR_VAR_VEL) # Variable velocity mode for singularity
movel(P3)
```

▪ **Related commands**

```
movel()/movec()/movesx()/moveb()/move_spiral()/amovel()/amovec()/
amovesx()/amoveb()/amove_spiral()
```

11. Force/Stiffness Control and Other User-Friendly Features

11.1 parallel_axis(x1, x2, x3, axis, ref)

▪ Features

This function matches the normal vector of the plane consists of points(x1, x2, x3) based on the ref coordinate(refer to get_normal(x1, x2, x3)) and the designated axis of the tool frame. The current position is maintained as the TCP position of the robot.

▪ Parameters

Parameter Name	Data Type	Default Value	Description
x1	posx	-	posx or
	list (float[6])		position list
x2	posx	-	posx or
	list (float[6])		position list
x3	posx	-	posx or
	list (float[6])		position list
axis	int	-	axis <ul style="list-style-type: none"> • DR_AXIS_X: x-axis • DR_AXIS_Y: y-axis • DR_AXIS_Z: z-axis
ref	int	DR_BASE	reference coordinate <ul style="list-style-type: none"> • DR_BASE: base coordinate • DR_WORLD: world coordinate • user coordinate : user difined

Note

- The ref argument is only available in M2.40 or later versions.

Other User-Friendly Features

▪ **Return**

Value	Description
0	Success
Negative value	Error

▪ **Exception**

Exception	Description
DR_Error (DR_ERROR_TYPE)	Parameter data type error occurred
DR_Error (DR_ERROR_VALUE)	Parameter value is invalid
DR_Error (DR_ERROR_RUNTIME)	C extension module error occurred
DR_Error (DR_ERROR_STOP)	Program terminated forcefully

▪ **Example**

```
x0 = posx(0, 0, 90, 0, 90, 0)
movej(x0)
x1 = posx(0, 500, 700, 30, 0, 90)
x2 = posx(500, 0, 700, 0, 0, 45)
x3 = posx(300, 100, 500, 45, 0, 45)
parallel_axis(x1, x2, x3, DR_AXIS_X, DR_WORLD)
# match the tool x axis and the normal vector of the plane consists of points(x1,x2,x3)
# based on the world coordinate
```

▪ **Related commands**

get_normal()/parallel_axis()/align_axis()/align_axis()

11.2 parallel_axis(vect, axis, ref)

▪ Features

This function matches the given vect direction based on the ref coordinate and the designated axis of the tool frame. The current position is maintained as the TCP position of the robot.

▪ Parameters

Parameter Name	Data Type	Default Value	Description
vect	list (float[3])	-	vector
axis	int	-	axis <ul style="list-style-type: none"> • DR_AXIS_X: x-axis • DR_AXIS_Y: y-axis • DR_AXIS_Z: z-axis
ref	int	DR_BASE	reference coordinate <ul style="list-style-type: none"> • DR_BASE: base coordinate • DR_WORLD: world coordinate • user coordinate: user defined

Note

- **The ref argument is only available in M2.40 or later versions.**

▪ Return

Value	Description
0	Success
Negative value	Error

▪ Exception

Exception	Description
DR_Error (DR_ERROR_TYPE)	Parameter data type error occurred
DR_Error (DR_ERROR_VALUE)	Parameter value is invalid
DR_Error (DR_ERROR_RUNTIME)	C extension module error occurred
DR_Error (DR_ERROR_STOP)	Program terminated forcefully



- **Example**

```
x0 = posx(0, 0, 90, 0, 90, 0)
movej(x0)
parallel_axis([1000, 700, 300], DR_AXIS_X, DR_WORLD)
# match the tool x axis and the vector([1000,700,300]) based on the world coordinate
```

- **Related commands**

parallel_axis()/align_axis()/align_axis()

11.3 align_axis(x1, x2, x3, pos, axis, ref)

Features

This function matches the normal vector of the plane consists of points(x1, x2, x3) based on the ref coordinate(refer to get_normal(x1, x2, x3)) and the designated axis of the tool frame. The robot TCP moves to the pos position.

Parameters

Parameter Name	Data Type	Default Value	Description
x1	posx	-	posx or position list
	list (float[6])		
x2	posx	-	posx or position list
	list (float[6])		
x3	posx	-	posx or position list
	list (float[6])		
pos	posx	-	posx or position list
	list (float[6])		
axis	int	-	axis <ul style="list-style-type: none"> • DR_AXIS_X: x-axis • DR_AXIS_Y: y-axis • DR_AXIS_Z: z-axis
ref	int	DR_BASE	reference coordinate <ul style="list-style-type: none"> • DR_BASE: base coordinate • DR_WORLD: world coordinate • user coordinate: user defined

Note

- The ref argument is only available in M2.40 or later versions.

Return

Value	Description
0	Success

Other User-Friendly Features

Value	Description
Negative value	Error

- **Exception**

Exception	Description
DR_Error (DR_ERROR_TYPE)	Parameter data type error occurred
DR_Error (DR_ERROR_VALUE)	Parameter value is invalid
DR_Error (DR_ERROR_RUNTIME)	C extension module error occurred
DR_Error (DR_ERROR_STOP)	Program terminated forcefully

- **Example**

```

p0 = posj(0,0,45,0,90,0)
movej(p0, v=30, a=30)

x1 = posx(0, 500, 700, 30, 0, 0)
x2 = posx(500, 0, 700, 0, 0, 0)
x3 = posx(300, 100, 500, 0, 0, 0)
pos = posx(400, 400, 500, 0, 0, 0)
align_axis(x1, x2, x3, pos, DR_AXIS_X, DR_BASE)
# match the tool x axis and the normal vector in the plane consists of points(x1, x2,
# x3) based on the base coordinate
    
```

- **Related commands**

get_normal()/align_axis()/parallel_axis()/parallel_axis()

11.4 align_axis(vect, pos, axis, ref)

▪ Features

This function matches the given vect direction based on the ref coordinate and the designated axis of the tool frame. The robot TCP moves to the pos position.

▪ Parameters

Parameter Name	Data Type	Default Value	Description
vect	list (float[3])	-	vector
pos	posx	-	posx or position list
	list (float[6])		
axis	int	-	axis <ul style="list-style-type: none"> • DR_AXIS_X: x-axis • DR_AXIS_Y: y-axis • DR_AXIS_Z: z-axis
ref	int	DR_BASE	reference coordinate <ul style="list-style-type: none"> • DR_BASE: base coordinate • DR_WORLD: world coordinate user coordinate: user defined

Note

- **The MOVE_REFERENCE_WORLD argument of ref is only available in M2.40 or later versions.**

▪ Return

Value	Description
0	Success
Negative value	Error

▪ Exception

Exception	Description
DR_Error (DR_ERROR_TYPE)	Parameter data type error occurred
DR_Error (DR_ERROR_VALUE)	Parameter value is invalid

Other User-Friendly Features

Exception	Description
DR_Error (DR_ERROR_RUNTIME)	C extension module error occurred
DR_Error (DR_ERROR_STOP)	Program terminated forcefully

- **Example**

```
p0 = posj(0,0,45,0,90,0)
movej(p0, v=30, a=30)

vect = [10, 20, 30]
pos = posx(100, 500, 700, 45, 0, 0)
align_axis(vect, pos, DR_AXIS_X)
```

- **Related commands**

`align_axis()/parallel_axis()/parallel_axis()`



11.5 is_done_bolt_tightening(m=0, timeout=0, axis=None)

▪ Features

This function monitors the tightening torque of the tool and returns True if the set torque (m) is reached within the given time and False if the given time has passed.

▪ Parameters

Parameter Name	Data Type	Default Value	Description
m	float	0	Target torque
timeout	float	0	Monitoring duration [sec]
axis	int	-	axis • DR_AXIS_X: x-axis • DR_AXIS_Y: y-axis • DR_AXIS_Z: z-axis

▪ Return

Value	Description
0	Success
Negative value	Error

▪ Exception

Exception	Description
DR_Error (DR_ERROR_TYPE)	Parameter data type error occurred
DR_Error (DR_ERROR_RUNTIME)	C extension module error occurred
DR_Error (DR_ERROR_STOP)	Program terminated forcefully

Other User-Friendly Features

▪ **Example**

```
p0 = posj(0,0,90,0,90,0)
movej(p0, v=30, a=30)

task_compliance_ctrl()
xd = posx(559, 34.5, 651.5, 0, 180.0, 60)
amovel(xd, vel=50, acc=50) # Bolt tightening motion

res = is_done_bolt_tightening(10, 5, DR_AXIS_Z)
    # Returns True if the tightening torque of 10Nm is reached within 5 seconds.
    # Returns False otherwise.
if res==True:
    # some action comes here for the case that bolt tightening is done
    x=1
else:
    # some action comes here for the case that it fails
    x=2
```

▪ **Related commands**

amovel()



11.6 release_compliance_ctrl()

▪ Features

This function terminates compliance control and begins position control at the current position.

▪ Parameters

Not applicable

▪ Return

Value	Description
0	Success
Negative value	Error

▪ Exception

Exception	Description
DR_Error (DR_ERROR_RUNTIME)	C extension module error occurred
DR_Error (DR_ERROR_STOP)	Program terminated forcefully

▪ Example

```
P0 = posj(0,0,90,0,90,0)
movej(P0)
task_compliance_ctrl()
set_stiffnessx([100, 100, 300, 100, 100, 100])
release_compliance_ctrl()
```

▪ Related commands

`task_compliance_ctrl()/set_stiffnessx()`

11.7 task_compliance_ctrl(stx, time)

▪ Features

This function begins task compliance control based on the preset reference coordinate system.

▪ Parameters (Stiffness TBD)

Parameter Name	Data Type	Default Value	Description
stx	float[6]	[3000, 3000, 3000, 200, 200, 200]	Three translational stiffnesses Three rotational stiffnesses
time	float	0	Stiffness varying time [sec] Range: 0 - 1.0 * Linear transition during the specified time

▪ Return

Value	Description
0	Success
Negative value	Error

▪ Exception

Exception	Description
DR_Error (DR_ERROR_TYPE)	Parameter data type error occurred
DR_Error (DR_ERROR_VALUE)	Parameter value is invalid
DR_Error (DR_ERROR_RUNTIME)	C extension module error occurred
DR_Error (DR_ERROR_STOP)	Program terminated forcefully

▪ Example

```
P0 = posj(0,0,90,0,90,0)
movej(P0)
task_compliance_ctrl()          # Begins with the default stiffness
set_stiffnessx([500, 500, 500, 100, 100, 100], time=0.5)
# Switches to the user-defined stiffness for 0.5 sec.
release_compliance_ctrl()

task_compliance_ctrl([500, 500, 500, 100, 100, 100])
```



Other User-Friendly Features

```
# Begins with the user-defined stiffness.  
release_compliance_ctrl()
```

- **Related commands**

set_stiffnessx()/release_compliance_ctrl()

11.8 set_stiffnessx(stx, time)

Features

This function sets the stiffness value based on the global coordinate(refer to set_ref_coord()). The linear transition from the current or default stiffness is performed during the time given as STX. The user-defined ranges of the translational stiffness and rotational stiffness are 0-20000N/m and 0-400Nm/rad, respectively.

Parameters

Parameter Name	Data Type	Default Value	Description
stx	float[6]	[500, 500, 500, 100, 100, 100]	Three translational stiffnesses Three rotational stiffnesses
time	float	0	Stiffness varying time [sec] Range: 0 - 1.0 * Linear transition during the specified time

Return

Value	Description
0	Success
Negative value	Error

Exception

Exception	Description
DR_Error (DR_ERROR_TYPE)	Parameter data type error occurred
DR_Error (DR_ERROR_VALUE)	Parameter value is invalid
DR_Error (DR_ERROR_RUNTIME)	C extension module error occurred
DR_Error (DR_ERROR_STOP)	Program terminated forcefully

Example

```

set_ref_coord(DR_WORLD)    # Global coordinate is the world coordinate
x0 = posx(0, 0, 90, 0, 90, 0)
movej(x0)
task_compliance_ctrl()
stx = [1, 2, 3, 4, 5, 6]
set_stiffnessx(stx)    # Set the stiffness value based on the global coordinate(world coordinate)
release_compliance_ctrl()
    
```



Other User-Friendly Features

- **Related commands**

`task_compliance_ctrl()/release_compliance_ctrl()`

11.9 calc_coord(x1, x2, x3, x4, ref, mod)

▪ Features

This function is only available for M2.50 or later versions.

This function returns a new user cartesian coordinate system by using up to 4 input poses ([x1]~[x4]), input mode [mod] and the reference coordinate system [ref]. The input mode is only valid when the number of input robot poses is 2.

In the case that the number of input poses is 1, the coordinate system is calculated using the position and orientation of x1.

In the case that the number of input poses is 2 and the input mode is 0, X-axis is defined by the direction from x1 to x2, and Z-axis is defined by the projection of the current Tool-Z direction onto the plane orthogonal to the x-axis. The origin is the position of x1.

In the case that the number of input poses is 2 and the input mode is 1, X-axis is defined by the direction from x1 to x2, and Z-axis is defined by the projection of the z direction of x1 onto the plane orthogonal to the X-axis. The origin is the position of x1.

In the case that the number of input poses is 3, X-axis is defined by the direction from x1 to x2. If a vector v is the direction from x1 to x3, Z-axis is defined by the cross product of X-axis and v (X-axis cross v). The origin is the position of x1.

In the case that the number of input poses is 4, the definition of axes is identical to the case that the number of input poses is 3, but the origin is the position of x4.

▪ Parameters

Parameter Name	Data Type	Default Value	Description
x1	Posx	-	posx or position list
	list (float[6])		
x2	Posx	-	posx or position list
	list (float[6])		
x3	Posx	-	posx or position list
	list (float[6])		
x4	Posx	-	posx or position list
	list (float[6])		



Other User-Friendly Features

Parameter Name	Data Type	Default Value	Description
ref	int	DR_BASE	reference coordinate <ul style="list-style-type: none"> DR_BASE: base coordinate DR_WORLD: world coordinate
mod	int	-	input mode (only valid when the number of input poses is 2) 0: defining z-axis based on the current Tool-z direction 1: defining z-axis based on the z direction of x1

Return

Value	Description
posx	Successful coordinate calculation Position information of the calculated coordinate

Exception

Exception	Description
DR_Error (DR_ERROR_TYPE)	Parameter data type error occurred
DR_Error (DR_ERROR_VALUE)	Parameter value is invalid
DR_Error (DR_ERROR_RUNTIME)	C extension module error occurred
DR_Error (DR_ERROR_STOP)	Program terminated forcefully

Example

```

pos1 = posx(500, 30, 500, 0, 0, 0)
pos2 = posx(400, 30, 500, 0, 0, 0)
pos3 = posx(500, 30, 600, 45, 180, 45)
pos4 = posx(500, -30, 600, 0, 180, 0)
pose_user1 = calc_coord(pos1, ref=DR_BASE, mod=0)
pose_user21 = calc_coord(pos1, pos2, ref=DR_WORLD, mod=0)
%% Define z-axis based on the Tool-z direction.
pose_user22 = calc_coord(pos1, pos2, ref=DR_BASE, mod=1)
%% Define z-axis based on the z direction of pos1
pose_user3 = calc_coord(pos1, pos2, pos3, ref=DR_BASE, mod=0)
pose_user4 = calc_coord(pos1, pos2, pos3, pos4, ref=DR_WORLD, mod=0)
ucart1 = set_user_cart_coord(pose_user1, ref=DR_BASE)
ucart2 = set_user_cart_coord(pose_user21, ref=DR_WORLD)

```



Other User-Friendly Features

- **Related commands**

- set_user_cart_coord()



11.10 set_user_cart_coord(pos, ref)

▪ Features

This function set a new user cartesian coordinate system using input pose [pos] and reference coordinate system[ref]. Up to 20 user coordinate systems can be set including the coordinate systems set within Workcell Item. Since the coordinate system set by this function is removed when the program is terminated, setting new coordinate systems within Workcell Item is recommended for maintaining the coordinate information.

▪ Parameters

Parameter Name	Data Type	Default Value	Description
pos	Posx	-	coordinate information (position and orientation)
	list (float[6])		
	list (float[6])		
ref	int	DR_BASE	reference coordinate • DR_BASE: base coordinate • DR_WORLD: world coordinate

▪ Return

Value	Description
Positive integer	Successful coordinate setting Set coordinate ID (101 - 200)
-1	Failed coordinate setting

▪ Exception

Exception	Description
DR_Error (DR_ERROR_TYPE)	Parameter data type error occurred
DR_Error (DR_ERROR_VALUE)	Parameter value is invalid
DR_Error (DR_ERROR_RUNTIME)	C extension module error occurred
DR_Error (DR_ERROR_STOP)	Program terminated forcefully

▪ Example

```
pos1 = posx(10, 20, 30, 0, 0, 0)
```



Other User-Friendly Features

```
pos2 = posx(30, 50, 70, 45, 180, 45)
user_id1 = set_user_cart_coord(pos1, ref=DR_BASE)
user_id2 = set_user_cart_coord(pos2, ref=DR_WORLD)
```

- **Related commands**

set_ref_coord()

11.11 set_user_cart_coord(x1, x2, x3, pos, ref)

Features

The user can set the new rectangular coordinate system using x1, x2, and x3 based on the ref coordinate. Creates a rectangular coordinate system with ux, uy, and uz as the vector for each axis and origin point is the pos based on the ref coordinate assuming that ¹⁾ux is the unit vector of x1x2 and uy is the unit vector of the vector that represents the shortest distance between x1x2 and x3. A maximum of 20 can be used, and the most recent 20 values are used if there are more than 20.

¹⁾Before M2.0.2 software version, ux is the unit vector of x2x1

Parameters

Parameter Name	Data Type	Default Value	Description
x1	Posx	-	posx or position list
	list (float[6])		
x2	Posx	-	posx or position list
	list (float[6])		
x3	Posx	-	posx or position list
	list (float[6])		
pos	Posx	-	posx or position list
	list (float[6])		
ref	int	DR_BASE	reference coordinate <ul style="list-style-type: none"> DR_BASE: base coordinate DR_WORLD: world coordinate

Note

- The ref argument is only available in M2.40 or later versions.

Return

Value	Description
Positive integer	Successful coordinate setting Set coordinate ID (101 - 200)
-1	Failed coordinate setting

Other User-Friendly Features

▪ **Exception**

Exception	Description
DR_Error (DR_ERROR_TYPE)	Parameter data type error occurred
DR_Error (DR_ERROR_VALUE)	Parameter value is invalid
DR_Error (DR_ERROR_RUNTIME)	C extension module error occurred
DR_Error (DR_ERROR_STOP)	Program terminated forcefully

▪ **Example**

```
x1 = posx(0, 500, 700, 0, 0, 0) # Ignores the Euler angle.  
x2 = posx(500, 0, 700, 0, 0, 0)  
x3 = posx(300, 100, 500, 0, 0)  
x4 = posx(300, 110, 510, 0, 0)  
pos = posx(10, 20, 30, 0, 0, 0)  
user_tc1 = set_user_cart_coord(x1, x2, x3, pos, DR_BASE)  
user_tc2 = set_user_cart_coord(x2, x3, x4, pos, DR_WORLD)
```

▪ **Related commands**

set_ref_coord()

11.12 set_user_cart_coord(u1, v1, pos, ref)

Features

The user can set the new rectangular coordinate system using `u1` and `v1` based on the `ref` coordinate. The origin point of the rectangular coordinate system is `pos` based on the `ref` coordinate while the x-axis and y-axis bases are given in the vectors `u1` and `v1`, respectively. Other directions are determined by $u1 \times v1$. If `u1` and `v1` are not orthogonal, `v1'`, that is perpendicular to `u1` on the surface spanned by `u1` and `v1`, is set as the vector in the y-axis direction.

Parameters

Parameter Name	Data Type	Default Value	Description
<code>u1</code>	<code>float[3]</code>	-	X-axis unit vector
<code>v1</code>	<code>float[3]</code>	-	Y-axis unit vector
<code>pos</code>	<code>posx</code> list (<code>float[6]</code>)	-	<code>posx</code> or position list
<code>ref</code>	<code>int</code>	<code>DR_BASE</code>	reference coordinate <ul style="list-style-type: none"> <code>DR_BASE</code>: base coordinate <code>DR_WORLD</code>: world coordinate

Note

- The `ref` argument is only available in M2.40 or later versions.

Return

Value	Description
Positive integer	Successful coordinate setting Set coordinate ID (101 - 200)
-1	Failed coordinate setting

Exception

Exception	Description
<code>DR_Error (DR_ERROR_TYPE)</code>	Parameter data type error occurred
<code>DR_Error (DR_ERROR_VALUE)</code>	Parameter value is invalid
<code>DR_Error (DR_ERROR_RUNTIME)</code>	C extension module error occurred



Other User-Friendly Features

Exception	Description
DR_Error (DR_ERROR_STOP)	Program terminated forcefully

▪ **Example**

```
u1 = [1, 1, 0]
v1 = [-1, 1, 0]
pos = posx(10, 20, 30, 0, 0, 0)
user_tc1 = set_user_cart_coord(u1, v1, pos)
user_tc1 = set_user_cart_coord(u1, v1, pos, DR_WORLD)
```

▪ **Related commands**

set_ref_coord()



11.13 `overwrite_user_cart_coord(id, pos, ref)`

▪ Features

This function is only available for M2.50 or later versions.

This function changes the pose and reference coordinate system of the requested user coordinate system [id] with the [pos] and [ref], respectively.

▪ Parameters

Parameter Name	Data Type	Default Value	Description
id	int	-	coordinate ID
pos	posx	-	posx or position list
time	list (float[6])	-	posx or position list
ref	Int	DR_BASE	reference coordinate DR_BASE : base coordinate DR_WORLD: world coordinate

▪ Return

Value	Description
Positive integer	Successful coordinate setting Set coordinate ID (101 - 200)
-1	Failed coordinate setting

▪ Exception

Exception	Description
DR_Error (DR_ERROR_TYPE)	Parameter data type error occurred
DR_Error (DR_ERROR_VALUE)	Parameter value is invalid
DR_Error (DR_ERROR_RUNTIME)	C extension module error occurred
DR_Error (DR_ERROR_STOP)	Program terminated forcefully

▪ Example

```
pose_user1 = posx(30, 40, 50, 0, 0, 0)
id_user = set_user_coord(pose_user1, ref=DR_BASE)
pose_user2 = posx(100, 150, 200, 45, 180, 0)
overwrite_user_coord(id_user, pose_user2, ref=DR_BASE)
```



Other User-Friendly Features

- **Related commands**

set_user_cart_coord



11.14 get_user_cart_coord(id)

▪ Features

This function is only available for M2.50 or later versions.

This function returns the pose and reference coordinate system of the requested user coordinate system [id].

▪ Parameters

Parameter Name	Data Type	Default Value	Description
id	int	-	coordinate ID

▪ Return

Value	Description
posx	Position and orientation information of the coordinate to get
ref	Reference coordinate of the coordinate to get

▪ Exception

Exception	Description
DR_Error (DR_ERROR_TYPE)	Parameter data type error occurred
DR_Error (DR_ERROR_VALUE)	Parameter value is invalid
DR_Error (DR_ERROR_RUNTIME)	C extension module error occurred
DR_Error (DR_ERROR_STOP)	Program terminated forcefully

▪ Example

```
pose_user1 = posx(10, 20, 30, 0, 0, 0)
id_user = set_user_coord(pose_user1, ref=DR_BASE)
pose, ref = get_user_cart_coord(id_user)
```

▪ Related commands

set_user_cart_coord()

11.15 set_desired_force(fd, dir, time, mod)

▪ Features

This function defines the target force, direction, translation time, and mode for force control based on the global coordinate.

▪ Parameters

Parameter Name	Data Type	Default Value	Description
fd	float[6]	[0, 0, 0, 0, 0, 0]	Three translational target forces Three rotational target moments
dir	int[6]	[0, 0, 0, 0, 0, 0]	Force control in the corresponding direction if 1 Compliance control in the corresponding direction if 0
time	float	0	Transition time of target force to take effect [sec] Range: 0 - 1.0
mod	int	DR_FC_MOD_ABS	DR_FC_MOD_ABS: Force control with absolute value DR_FC_MOD_REL: force control with relative value to initial state (the instance when this function is called)

▪ Return

Value	Description
0	Success
Negative value	Error

▪ Exception

Exception	Description
DR_Error (DR_ERROR_TYPE)	Parameter data type error occurred
DR_Error (DR_ERROR_VALUE)	Parameter value is invalid
DR_Error (DR_ERROR_RUNTIME)	C extension module error occurred

Other User-Friendly Features

Exception	Description
DR_Error (DR_ERROR_STOP)	Program terminated forcefully

 **Note**

- The value of external force refers to the sensor measurement at terminating the force control (control mode transition to compliance control) by the command `release_force()`. Therefore, the variation in external force can occur if the option `mod=DR_FC_MOD_REL` is applied.
- Tool weight and external force value refer to the sensor measurement regardless of the setting for 'mod'

 **Caution**

- To retain the accuracy in force control, it is recommended to start force control with setting `mod=DR_FC_MOD_REL` near the contact point.

Example

```

set_ref_coord(DR_TOOL)
x0 = posx(0, 0, 90, 0, 90, 0)
movej(x0)
task_compliance_ctrl(stx=[500, 500, 500, 100, 100, 100])
fd = [0, 0, 0, 0, 0, 10]
fctrl_dir= [0, 0, 1, 0, 0, 1]
set_desired_force(fd, dir=fctrl_dir, mod=DR_FC_MOD_REL)
# Executed in the global coordinate(tool coordinate)
# Zero force control in the z-axis direction of the tool, moment control in the z-axis
direction of the tool, and compliance control in the other directions
# Force control with the relative value to the sensor measurement at starting the force
control
  
```

Related commands

`release_force()/task_compliance_ctrl()/set_stiffnessx()/release_compliance_ctrl()`

11.16 release_force(time=0)

▪ Features

This function reduces the force control target value to 0 through the time value and returns the task space to adaptive control.

▪ Parameters

Parameter Name	Data Type	Default Value	Description
time	float	0	Time needed to reduce the force Range: 0 - 1.0

▪ Return

Value	Description
0	Success
Negative value	Error

▪ Exception

Exception	Description
DR_Error (DR_ERROR_RUNTIME)	C extension module error occurred
DR_Error (DR_ERROR_STOP)	Program terminated forcefully

▪ Example

```

j0 = posj(0, 0, 90, 0, 90, 0)
x0 = posx(0, 0, 0, 0, 0, 0)
x1 = posx(0, 500, 700, 0, 180, 0)
x2 = posx(300, 100, 700, 0, 180, 0)
x3 = posx(300, 100, 500, 0, 180, 0)
set_velx(100,20)
set_accx(100,20)
movej(j0, vel=10, acc=10)
movel(x2)
task_compliance_ctrl(stx = [500, 500, 500, 100, 100, 100])
fd = [0, 0, 0, 0, 0, 10]
fctrl_dir= [0, 0, 1, 0, 0, 1]
set_desired_force(fd, dir=fctrl_dir, time=1.0)
movel(x3, v=10)
release_force(0.5)
release_compliance_ctrl()
    
```

Other User-Friendly Features

 ▪ **Related commands**

set_desired_force()/task_compliance_ctrl()/set_stiffnessx()/release_compliance_ctrl()

11.17 check_position_condition(axis, min, max, ref, mod, pos)

 ▪ **Features**

This function checks the status of the given position. This condition can be repeated with the while or if statement. **Axis and pos of input paramets are based on the ref coordinate.**

 ▪ **Parameters**

Parameter Name	Data Type	Default Value	Description
axis	int	-	axis <ul style="list-style-type: none"> • DR_AXIS_X: x-axis • DR_AXIS_Y: y-axis • DR_AXIS_Z: z-axis
min	float	DR_COND_NONE	Minimum value
max	float	DR_COND_NONE	Maximum value
ref	int	None	reference coordinate <ul style="list-style-type: none"> • DR_BASE : base coordinate • DR_WORLD : world coordinate • DR_TOOL : tool coordinate • user coordinate: User defined
mod	int	DR_MV_MOD_ABS	Movement basis <ul style="list-style-type: none"> • DR_MV_MOD_ABS: Absolute • DR_MV_MOD_REL: Relative
pos	posx list (float[6])	-	posx or position list

 **Note**

- The absolution position is used if the mod is DR_MV_MOD_ABS.
- The pos position is used if the mod is DR_MV_MOD_REL.
- Pos is meaningful only if the mod is DR_MV_MOD_REL.

Other User-Friendly Features

▪ Return

Value	Description
True	The condition is True.
False	The condition is False.

▪ Exception

Exception	Description
DR_Error (DR_ERROR_TYPE)	Parameter data type error occurred
DR_Error (DR_ERROR_VALUE)	Parameter value is invalid
DR_Error (DR_ERROR_RUNTIME)	C extension module error occurred
DR_Error (DR_ERROR_STOP)	Program terminated forcefully

▪ Example

```

CON1= check_position_condition(DR_AXIS_X, min=-5, max=0, ref=DR_WORLD)
CON2= check_position_condition(DR_AXIS_Y, max=700)
CON3= check_position_condition(DR_AXIS_Z, min=-10, max=-5)    # -10 ≤ z ≤ -5
CON4= check_position_condition(DR_AXIS_Z, min=30)             # 30 ≤ z

CON5= check_position_condition(DR_AXIS_Z,min=-10,max=-5, ref=DR_BASE)
                                           # -10 ≤ z ≤ -5

CON6= check_position_condition(DR_AXIS_Z,min=-10,max=-5,
mod=DR_MV_MOD_ABS)
      # -10 ≤ z ≤ -5

posx1 = posx(400, 500, 800, 0, 180,0)
CON7= check_position_condition(DR_AXIS_Z,min=-10,max=-5,mod =
DR_MV_MOD_REL, pos=posx1)                                # posx1_(z) -
10 ≤ z ≤ posx1_(z) - 5
    
```

▪ Related commands

check_force_condition()/check_orientation_condition()/set_ref_coord()



11.18 check_force_condition(axis, min, max, ref)

▪ Features

This function checks the status of the given force. It disregards the force direction and only compares the sizes. This condition can be repeated with the while or if statement. **Measuring the force, axis is based on the ref coordinate and measuring the moment, axis is based on the tool coordinate.**

▪ Parameters

Parameter Name	Data Type	Default Value	Description
axis	int	-	axis <ul style="list-style-type: none"> • DR_AXIS_X: x-axis • DR_AXIS_Y: y-axis • DR_AXIS_Z: z-axis • DR_AXIS_A: x-axis rotation • DR_AXIS_B: y-axis rotation • DR_AXIS_C: z-axis rotation
min	float	DR_COND_NONE	Minimum value (min ≥ 0)
max	float	DR_COND_NONE	Maximum value (max ≥ 0)
ref	int	None	reference coordinate <ul style="list-style-type: none"> • DR_BASE : base coordinate • DR_WORLD : world coordinate • DR_TOOL : tool coordinate • user coordinate: User defined

▪ Return

Value	Description
True	The condition is True.
False	The condition is False.

▪ Exception

Exception	Description
DR_Error (DR_ERROR_TYPE)	Parameter data type error occurred

Other User-Friendly Features

Exception	Description
DR_Error (DR_ERROR_VALUE)	Parameter value is invalid
DR_Error (DR_ERROR_RUNTIME)	C extension module error occurred
DR_Error (DR_ERROR_STOP)	Program terminated forcefully

- **Example**

```
fcon1 = check_force_condition(DR_AXIS_Z, min=5, max=10, DR_WORLD)
# 5 ≤ fz ≤ 10

while (fcon1):
    fcon2 = check_force_condition(DR_AXIS_C, min=30)           # 30 ≤ mz
    pcon1 = check_position_condition(DR_AXIS_X, min=0, max=0.1) # 0 ≤ x ≤ 0.1

    if (fcon2 and pcon1):
        break
```

- **Related commands**

check_position_condition()/check_orientation_condition()/set_ref_coord()

11.19 check_orientation_condition(axis, min, max, ref, mod)

Features

This function checks the difference between the current pose and the specified pose of the robot end effector. It returns the difference between the current pose and the specified pose in rad with the algorithm that transforms it to a rotation matrix using the “AngleAxis” technique. It returns True if the difference is positive (+) and False if the difference is negative (-). It is used to check if the difference between the current pose and the rotating angle range is + or -. For example, the function can use the direct teaching position to check if the difference from the current position is + or - and then create the condition for the orientation limit. This condition can be repeated with the while or if statement.

- Setting Min only: True if the difference is + and False if -
- Setting Min and Max: True if the difference from min is - while the difference from max is + and False otherwise
- Setting Max only: True if the maximum difference is + and False otherwise

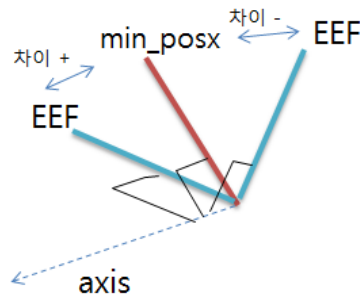

Parameters

Parameter Name	Data Type	Default Value	Description
axis	int	-	axis • DR_AXIS_A: x-axis rotation • DR_AXIS_B: y-axis rotation • DR_AXIS_C: z-axis rotation
min	posx	-	posx or
	list (float[6])	-	position list
	posx	-	

Other User-Friendly Features

Parameter Name	Data Type	Default Value	Description
max	list (float[6])		posx or position list
ref	int	None	reference coordinate <ul style="list-style-type: none"> DR_BASE : base coordinate DR_WORLD : world coordinate DR_TOOL : tool coordinate user coordinate: User defined
mod	int	DR_MV_MOD_ABS	Movement basis <ul style="list-style-type: none"> DR_MV_MOD_ABS: Absolute

Return

Value	Description
True	The condition is True.
False	The condition is False.

Exception

Exception	Description
DR_Error (DR_ERROR_TYPE)	Parameter data type error occurred
DR_Error (DR_ERROR_VALUE)	Parameter value is invalid
DR_Error (DR_ERROR_RUNTIME)	C extension module error occurred
DR_Error (DR_ERROR_STOP)	Program terminated forcefully

Example

```
posx1 = posx(400,500,800,0,180,30)
posx2 = posx(400,500,500,0,180,60)
```

```
CON1= check_orientation_condition(DR_AXIS_C, min=posx1, max= posx2)
# If the current task coordinate posxc = posx(400, 500, 500, 0, 180, 40)
# CON1=True since posx1 Rz=30 < posxc Rz=40 < posx2 Rz=60
```

```
CON2= check_orientation_condition(DR_AXIS_C, min=posx1)
# If the current task coordinate posxc = posx(400, 500, 500, 0, 180, 15)
# CON2=False since posx1 Rz=30 > posxc Rz=15
```



Other User-Friendly Features

```
CON3= check_orientation_condition(DR_AXIS_C, max= posx2)
# If the current task coordinate posxc = posx(400, 500, 500, 0, 180, 75)
# CON2=False since posx1 Rz=75 > posxc Rz=60
```

- **Related commands**

`check_position_condition()/check_force_condition()/check_orientation_condition()`
`/set_ref_coord()`

11.20 check_orientation_condition(axis, min, max, ref, mod, pos)

▪ Features

This function checks the difference between the current pose and the rotating angle range of the robot end effector. It returns the difference (in rad) between the current pose and the rotating angle range with the algorithm that transforms it to a rotation matrix using the "AngleAxis" technique. It returns True if the difference is positive (+) and False if the difference is negative (-). It is used to check if the difference between the current pose and the rotating angle range is + or -. For example, the function can be used to set the rotating angle range to min and max at any reference position, and then determine the orientation limit by checking if the difference from the current position is + or -. This condition can be repeated with the while or if statement.

- Setting Min only: True if the difference is + and False if -
- Setting Min and Max: True if the difference from min is - while the difference from max is + and False if the opposite.
- Setting Max only: True if the maximum difference is + and False otherwise

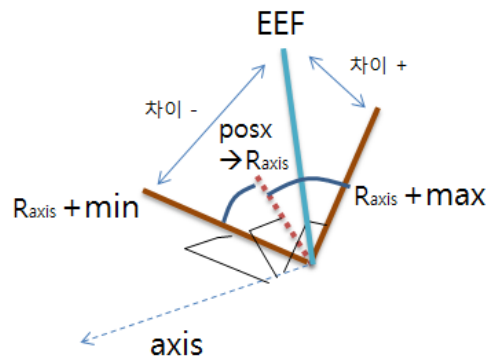

Note

Range of rotating angle: This means the relative angle range (min, max) based on the specified axis from **a given position based on the ref coordinate**.

▪ Parameters

Parameter Name	Data Type	Default Value	Description
axis	int	-	axis <ul style="list-style-type: none"> • DR_AXIS_X: x-axis rotation • DR_AXIS_Y: y-axis rotation



Other User-Friendly Features

Parameter Name	Data Type	Default Value	Description
			<ul style="list-style-type: none"> DR_AXIS_Z: z-axis rotation
min	float	DR_COND_NONE	Minimum value
max	float	DR_COND_NONE	Maximum value
ref	int	None	reference coordinate <ul style="list-style-type: none"> DR_BASE : base coordinate DR_WORLD : world coordinate DR_TOOL : tool coordinate user coordinate: User defined
mod	int	DR_MV_MOD_ABS	Movement basis <ul style="list-style-type: none"> DR_MV_MOD_REL: Relative
pos	posx	-	posx or
	list (float[6])		position list

Return

Value	Description
True	The condition is True.
False	The condition is False.

Exception

Exception	Description
DR_Error (DR_ERROR_TYPE)	Parameter data type error occurred
DR_Error (DR_ERROR_VALUE)	Parameter value is invalid
DR_Error (DR_ERROR_RUNTIME)	C extension module error occurred
DR_Error (DR_ERROR_STOP)	Program terminated forcefully

Example

```

posx1 = posx(400,500,800,0,180,15)
CON1= check_orientation_condition(DR_AXIS_C, min=-5, mod=DR_MV_MOD_REL,
pos=posx1, DR_WORLD)
# If the current task coordinate posxc = posx(400, 500, 500, 0, 180, 40)
# CON1=True since posx1 Rz=15 - (min=5) < posxc Rz=40

```



Other User-Friendly Features

```
CON1= check_orientation_condition(DR_AXIS_C, max=5, mod=DR_MV_MOD_REL,  
pos=posx1)  
# If the current task coordinate posxc = posx(400, 500, 500, 0, 180, 40)  
# CON1=False since posxc Rz=40 > posx1 Rz=15 + (max=5)
```

▪ **Related commands**

`check_position_condition()/check_force_condition()/check_orientation_condition()`
`/set_ref_coord()`



11.21 coord_transform(pose_in, ref_in, ref_out)

▪ Features

This function transforms given task position expressed in reference coordinate, 'ref_in' to task position expressed in reference coordinate, 'ref_out'. It returns transformed task position. It supports calculation of coordinate transformation for the following cases.

- (ref_in) world reference coordinate → (ref_out) world reference coordinate
- (ref_in) world reference coordinate → (ref_out) base reference coordinate
- (ref_in) world reference coordinate → (ref_out) tool reference coordinate
- (ref_in) world reference coordinate → (ref_out) user reference coordinate
- (ref_in) base reference coordinate → (ref_out) base reference coordinate
- (ref_in) base reference coordinate → (ref_out) tool reference coordinate
- (ref_in) base reference coordinate → (ref_out) user reference coordinate
- (ref_in) tool reference coordinate → (ref_out) world reference coordinate
- (ref_in) tool reference coordinate → (ref_out) base reference coordinate
- (ref_in) tool reference coordinate → (ref_out) tool reference coordinate
- (ref_in) tool reference coordinate → (ref_out) user reference coordinate
- (ref_in) user reference coordinate → (ref_out) world reference coordinate
- (ref_in) user reference coordinate → (ref_out) base reference coordinate
- (ref_in) user reference coordinate → (ref_out) tool reference coordinate
- (ref_in) user reference coordinate → (ref_out) user reference coordinate

▪ Parameters

Parameter Name	Data Type	Default Value	Description
Pose_in	posx	-	posx
ref_in	float	DR_COND_NONE	reference coordinate before transformation <ul style="list-style-type: none">• DR_BASE : base coordinate• DR_WORLD : world coordinate• DR_TOOL : tool coordinate• user coordinate: User defined
ref_out	float	DR_COND_NONE	reference coordinate after transformation

Other User-Friendly Features

Parameter Name	Data Type	Default Value	Description
			<ul style="list-style-type: none"> DR_BASE : base coordinate DR_WORLD : world coordinate DR_TOOL : tool coordinate user coordinate: User defined

▪ **Return**

Value	Description
pos	posx

▪ **Exception**

Exception	Description
DR_Error (DR_ERROR_TYPE)	Parameter data type error occurred
DR_Error (DR_ERROR_VALUE)	Parameter value is invalid
DR_Error (DR_ERROR_RUNTIME)	C extension module error occurred
DR_Error (DR_ERROR_STOP)	Program terminated forcefully

▪ **Example**

```

base_pos = posx(400,500,800,0,180,15)
# If task position based on base reference coordinate base_pos =
posx(400,500,800,0,180,15)

tool_pos = coord_transform(base_pos, DR_BASE, DR_TOOL)
# Transform task position(base_pos) expressed in base reference coordinate to task
position expressed in tool reference coordinate
# This command returns task position expressed in tool reference coordinate and the
result value is stored in tool_pos

```

▪ **Related commands**

set_user_cart_coord()/get_current_posx()/get_desired_posx()/set_ref_coord()

12. System Functions

12.1 Robot Mode

12.1.1 set_robot_mode(robot_mode)

▪ Features

This function is to set the operation mode (manual / automatic) of the robot controller. Motion command is available in both modes, but manual handguiding is available in manual mode and operates in deceleration mode for safety.

In automatic mode, manual handguiding is not possible and operates in normal speed mode.

Manual mode: robot LED lights up blue

Auto mode: robot LED lights up in white

▪ Parameters

Parameter Name	Data Type	Default Value	Description
Robot_mode	int	-	<ul style="list-style-type: none"> ROBOT_MODE_MANUAL : 0 ROBOT_MODE_AUTONOMOUS : 1

▪ Return

Value	Description
0	Success
Negative value	Failed

▪ Example

```
#...
set_robot_mode(ROBOT_MODE_MANUAL)
#...
#...
#...
set_robot_mode(ROBOT_MODE_AUTONOMOUS)
...

```

12.1.2 get_robot_mode()

▪ Features

This function reads the current operating mode of the robot controller.

▪ Parameters

Parameter Name	Data Type	Default Value	Description
none	-	-	-

▪ Return

Value	Description
ROBOT_MODE_MANUAL (0)	Robot mode is manual.
ROBOT_MODE_AUTONOMOUS (1)	Robot mode is auto.

▪ Example

```
#...  
if get_robot_mode() != ROBOT_MODE_AUTONOMOUS:  
    set_robot_mode(ROBOT_MODE_AUTONOMOUS)  
#...
```

12.1.3 get_last_alarm()

- **Feature**

로봇 제어기의 최근 알람 로그를 읽어오는 함수입니다.

- **Parameters**

Not applicable

- **Return**

Value	Description
level	로그 메시지 레벨 0 : Info 1 : Warning 2 : Alarm
group	로그 메시지 그룹
index	알람 로그 번호
param	알람 로그 파라미터

- **Example**

```
#...  
index = get_last_alarm().index  
print(str(index))  
#...
```

12.1.4 set_safe_stop_reset_type(reset_type)

▪ Feature

When the operation status information of the robot controller is SAFE_STOP, it is a function to define a series of actions that are automatically executed after the change of status using the set_robot_control function. If the robot operation mode is automatic, the program can be defined and set again. In the manual mode, this setting is ignored.

▪ Parameters

Parameter Name	Data Type	Default Value	Description
reset_type	int8	0	Reset Type STOP : 1 RESUME : 2

▪ Return

Value	Description
0	Success
1	Failed

▪ Example

```
#...
robot_state = get_robot_mode()
if robot_state == ROBOT_MODE_AUTONOMOUS:
    set_safe_reset_type(SAFE_STOP_PROGRAM_RESUME);
#...
```

12.1.5 set_robot_speed_mode(speed_mode)

- **Feature**

This is a function for setting and changing the speed mode currently being operated by the controller.

- **Parameters**

Parameter Name	Data Type	Default Value	Description
speed_mode	int8	-	Robot Speed mode 0 : normal mode 1 : reduced mode

- **Return**

Value	Description
0	Failed
1	Success

- **Example**

```
if get_robot_speed_mode() == SPEED_REDUCED_MODE:  
    #When in deceleration mode, change to constant speed mode  
    set_robot_speed_mode(SPEED_NORMAL_MODE)
```

12.1.6 get_robot_speed_mode()

- **Feature**

This is a function to check the current speed mode (normal mode, deceleration mode) information from the robot controller.

- **Parameters**

Not applicable

- **Return**

Value	Description
robot_speed	robot speed mode 0 : normal mode 1 : reduced mode

- **Example**

```
if get_robot_speed_mode() == SPEED_REDUCED_MODE:  
    # When in deceleration mode, change to constant speed mode  
    set_robot_speed_mode(SPEED_NORMAL_MODE)
```



12.1.7 set_robot_system(robot_system)

▪ **Feature**

This is a function for setting and changing the current operating robot system in the robot controller.

▪ **Parameters**

Parameter Name	Data Type	Default Value	Description
robot_system	int8	-	robot system info 0 : Real 1 : Virtual

▪ **Return**

Value	Description
0	Failed
1	Success

▪ **Example**

```
if(get_robot_system() != ROBOT_SYSTEM_REAL):  
    #Automatic mode switching  
    set_robot_system(ROBOT_SYSTEM_REAL)  
else :  
    #do somting ...
```

12.1.8 get_robot_system()

- **Feature**

This function reads the current operating robot system from the robot controller.

- **Parameters**

Not applicable

- **Return**

Value	Description
0	Real
1	Virtual

- **Example**

```
if get_robot_system() != ROBOT_SYSTEM_REAL:
    # Automatic mode switching
    set_robot_system(ROBOT_SYSTEM_REAL)
else:
    #do somting ...
```



12.1.9 get_robot_state()

- **Feature**

This is for checking the current operation status information of the robot controller.

- **Parameters**

Not applicable

- **Return**

Value	Description
robot_state	Robot status 0 : Initializing 1 : Standby 2 : Moving 3 : SAFE OFF 4 : Teaching 5 : SAFE STOP 6 : Emergency Stop 7 : Homming 8 : Recovery

- **Example**

```
if get_robot_state() == STATE_STANDBY:  
    if get_robot_mode() == ROBOT_MODE_AUTONOMOUS:  
        # Manual Mode  
        # do something
```

12.2 IO

12.2.1 set_digital_output(index, val =None)

▪ Features

This function sends a signal at the digital contact point of the controller. A value saved in the digital output register is output as a digital signal.

▪ Parameters

Parameter Name	Data Type	Default Value	Description
index	int	-	I/O contact number mounted on the controller <ul style="list-style-type: none"> Val argument existing: A number between 1 and 16 No val argument: 1 ~ 16 , -1 ~ -16 (A positive number means ON while a negative number means OFF.)
val	int	-	I/O value <ul style="list-style-type: none"> ON: 1 OFF: 0

Note

If val is omitted, the positive number becomes ON and the negative number OFF according to the sign of the argument index.

▪ Return

Value	Description
0	Success
Negative value	Failed

▪ Exception

Exception	Description
DR_Error (DR_ERROR_TYPE)	Parameter data type error occurred
DR_Error (DR_ERROR_VALUE)	Parameter value is invalid
DR_Error (DR_ERROR_RUNTIME)	C extension module error occurred
DR_Error (DR_ERROR_STOP)	Program terminated forcefully



▪ **Example**

```
set_digital_output(1, ON)           # No. 1 contact ON
set_digital_output(16, OFF)        # No. 16 contact OFF
set_digital_output(3)              #No. 3 contact ON (A positive number means ON if
the argument val is omitted.)
set_digital_output(-3)             #No. 3 contact OFF (A negative number means OFF
if the argument val is omitted.)
```

12.2.2 get_digital_output(index)

- **Features**

This service reads the current digital IO output status

- **Parameters**

Parameter Name	Data Type	Default Value	Description
index	int	-	A number 1 - 16 which means the contact number of I/O mounted on the controller.

- **Return**

Value	Description
1	ON
0	OFF
Negative value	Failed

- **Exception**

Exception	Description
DR_Error (DR_ERROR_TYPE)	Parameter data type error occurred
DR_Error (DR_ERROR_VALUE)	Parameter value is invalid
DR_Error (DR_ERROR_RUNTIME)	C extension module error occurred
DR_Error (DR_ERROR_STOP)	Program terminated forcefully

- **Example**

```

out_state1 = get_digital_output(1)    #Read of current output status of contact 1
out_state8 = get_digital_output(8)    #Read of current output status of contact 8

```



12.2.3 get_digital_input(index)

▪ **Features**

This function reads the signals from digital contact points of the controller and reads the digital input contact value.

▪ **Parameters**

Parameter Name	Data Type	Default Value	Description
index	int	-	A number 1 - 16 which means the contact number of I/O mounted on the controller.

▪ **Return**

Value	Description
1	ON
0	OFF
Negative value	Failed

▪ **Exception**

Exception	Description
DR_Error (DR_ERROR_TYPE)	Parameter data type error occurred
DR_Error (DR_ERROR_VALUE)	Parameter value is invalid
DR_Error (DR_ERROR_RUNTIME)	C extension module error occurred
DR_Error (DR_ERROR_STOP)	Program terminated forcefully

▪ **Example**

```
in1 = get_digital_input(1)    # Reads the no. 1 contact
in8 = get_digital_input(8)    # Reads the no. 8 contact
```

12.2.4 set_tool_digital_output(index, val=None)

▪ **Features**

This function sends the signal of the robot tool from the digital contact point.

▪ **Parameters**

Parameter Name	Data Type	Default Value	Description
index	int	-	I/O contact number mounted on the robot arm <ul style="list-style-type: none"> • Val argument existing: A number between 1 and 6 • No val argument: 1 ~ 6 , -1 ~ -6 (A positive number means ON while a negative number means OFF.)
val	int	-	I/O value: The value to output

 **Note**

If val is omitted, the positive number becomes ON and the negative number OFF according to the sign of the argument index.

▪ **Return**

Value	Description
0	Success
Negative value	Error

▪ **Exception**

Exception	Description
DR_Error (DR_ERROR_TYPE)	Parameter data type error occurred
DR_Error (DR_ERROR_VALUE)	Parameter value is invalid
DR_Error (DR_ERROR_RUNTIME)	C extension module error occurred
DR_Error (DR_ERROR_STOP)	Program terminated forcefully

▪ **Example**

```

set_tool_digital_output(1, ON) # Sets the no. 1 contact of the robot arm ON
set_tool_digital_output(6, OFF) # Sets the no. 6 contact of the robot arm OFF
set_tool_digital_output(3 #No. 3 contact ON (A positive number
                           means ON if the argument val is omitted.)

```



```
set_tool_digital_output(-3) #No. 3 contact OFF (A negative number means OFF if the argument val is omitted.)
```

12.2.5 get_tool_digital_output(index)

▪ Features

This service reads the current tool IO output status.

▪ Parameters

Parameter Name	Data Type	Default Value	Description
index	int	-	I/O contact number (1-6) mounted on the robot tool

▪ Return

Value	Description
1	ON
0	OFF
Negative value	Failed

▪ Exception

Exception	Description
DR_Error (DR_ERROR_TYPE)	Parameter data type error occurred
DR_Error (DR_ERROR_VALUE)	Parameter value is invalid
DR_Error (DR_ERROR_RUNTIME)	C extension module error occurred
DR_Error (DR_ERROR_STOP)	Program terminated forcefully

▪ Example

```
out_state1 = get_tool_digital_output(1) # Read of current output status of contact 1  
out_state6 = get_tool_digital_output(6) # Read of current output status of contact 6
```

12.2.6 get_tool_digital_input(index)

▪ Features

This function reads the signal of the robot tool from the digital contact point.

▪ Parameters

Parameter Name	Data Type	Default Value	Description
index	int	-	I/O contact number (1-6) mounted on the robot tool

▪ Return

Value	Description
1	ON
0	OFF
Negative value	Failed

▪ Exception

Exception	Description
DR_Error (DR_ERROR_TYPE)	Parameter data type error occurred
DR_Error (DR_ERROR_VALUE)	Parameter value is invalid
DR_Error (DR_ERROR_RUNTIME)	C extension module error occurred
DR_Error (DR_ERROR_STOP)	Program terminated forcefully

▪ Example

```
get_tool_digital_input(1)    # Reads the no. 1 contact of tool I/O
get_tool_digital_input(6)    # Reads the no. 6 contact of tool I/O
```

12.2.7 set_mode_analog_output(ch, mod)

▪ Features

This function sets the channel mode of the controller analog output.

▪ Parameters

Parameter Name	Data Type	Default Value	Description
ch	int	-	<ul style="list-style-type: none"> 1 : channel 1 2 : channel 2
mod	int	-	analog io mode <ul style="list-style-type: none"> DR_ANALOG_CURRENT: Current mode DR_ANALOG_VOLTAGE: Voltage mode

▪ Return

Value	Description
0	Success
Negative value	Failed

▪ Exception

Exception	Description
DR_Error (DR_ERROR_TYPE)	Parameter data type error occurred
DR_Error (DR_ERROR_VALUE)	Parameter value is invalid
DR_Error (DR_ERROR_RUNTIME)	C extension module error occurred
DR_Error (DR_ERROR_STOP)	Program terminated forcefully

▪ Example

```
# Sets analog_output channel 1 to the current mode.
set_mode_analog_output(ch=1, mod=DR_ANALOG_CURRENT)

# Sets analog_output channel 2 to the voltage mode.
set_mode_analog_output(ch=2, mod=DR_ANALOG_VOLTAGE)
```

12.2.8 set_mode_analog_input(ch, mod)

▪ Features

This function sets the channel mode of the controller analog input.

▪ Parameters

Parameter Name	Data Type	Default Value	Description
ch	int	-	<ul style="list-style-type: none"> 1 : channel 1 2 : channel 2
mod	int	-	analog io mode <ul style="list-style-type: none"> DR_ANALOG_CURRENT: Current mode DR_ANALOG_VOLTAGE: Voltage mode

▪ Return

Value	Description
0	Success
Negative value	Failed

▪ Exception

Exception	Description
DR_Error (DR_ERROR_TYPE)	Parameter data type error occurred
DR_Error (DR_ERROR_VALUE)	Parameter value is invalid
DR_Error (DR_ERROR_RUNTIME)	C extension module error occurred
DR_Error (DR_ERROR_STOP)	Program terminated forcefully

▪ Example

```
# Sets analog_input channel 1 to the current mode.
set_mode_analog_input(ch=1, mod=DR_ANALOG_CURRENT)

# Sets analog_input channel 2 to the voltage mode.
set_mode_analog_input(ch=2, mod=DR_ANALOG_VOLTAGE)
```

12.2.9 set_analog_output(ch, val)

▪ Features

This function outputs the channel value corresponding to the controller analog output.

▪ Parameters

Parameter Name	Data Type	Default Value	Description
ch	int	-	<ul style="list-style-type: none"> 1 : channel 1 2 : channel 2
val	float	-	analog output value <ul style="list-style-type: none"> Current mode: 4.0~20.0 [mA] Voltage mode: 0~10.0 [V]

▪ Return

Value	Description
0	Success
Negative value	Failed

▪ Exception

Exception	Description
DR_Error (DR_ERROR_TYPE)	Parameter data type error occurred
DR_Error (DR_ERROR_VALUE)	Parameter value is invalid
DR_Error (DR_ERROR_RUNTIME)	C extension module error occurred
DR_Error (DR_ERROR_STOP)	Program terminated forcefully

▪ Example

```

set_mode_analog_output(ch=1, mod=DR_ANALOG_CURRENT) #out ch1=current
mode
set_mode_analog_output(ch=2, mod=DR_ANALOG_VOLTAGE) #out ch1=voltage
mode

set_analog_output(ch=1, val=5.2) # Outputs 5.2 mA to channel 1
set_analog_output(ch=2, val=10.0) #Outputs 10V to channel 2
    
```

12.2.10 get_analog_input(ch)

▪ Features

This function reads the channel value corresponding to the controller analog input.

▪ Parameters

Parameter Name	Data Type	Default Value	Description
ch	int	-	<ul style="list-style-type: none"> 1 : channel 1 2 : channel 2

▪ Return

Value	Description
float	The analog input value of the specified channel <ul style="list-style-type: none"> Current mode: 4.0~20.0 [mA] Voltage mode: 0~10.0 [V]

▪ Exception

Exception	Description
DR_Error (DR_ERROR_TYPE)	Parameter data type error occurred
DR_Error (DR_ERROR_VALUE)	Parameter value is invalid
DR_Error (DR_ERROR_RUNTIME)	C extension module error occurred
DR_Error (DR_ERROR_STOP)	Program terminated forcefully

▪ Example

```

set_mode_analog_input(ch=1, mod=DR_ANALOG_CURRENT) #input ch1=current
mode
set_mode_analog_input(ch=2, mod=DR_ANALOG_VOLTAGE) #input ch2=voltage
mode

Cur = get_analog_input(1) # Reads the analog input current value of channel 1
Vol = get_analog_input(2) # Reads the analog input voltage value of channel 2.
    
```

13. External Communication Functions

13.1 Modbus

13.1.1 add_modbus_signal (ip, port, name, reg_type, index, value=0)

▪ Features

This function registers the ModbusTCP signal. The Modbus I/O must be set in the Teach Pendant I/O set-up menu. Use this command only for testing if it is difficult to use the Teach Pendant. The Modbus menu is disabled in the Teach Pendant if it is set using this command.

▪ Parameters

Parameter Name	Data Type	Default Value	Description
ip	string	-	IP address of the ModbusTCP module
port	int	-	Port number of the ModbusTCP module
name	string	-	Modbus signal name
reg_type	int	-	Modbus signal type <ul style="list-style-type: none"> • DR_MODBUS_DIG_INPUT • DR_MODBUS_DIG_OUTPUT • DR_MODBUS_REG_INPUT • DR_MODBUS_REG_OUTPUT
index	int	-	Modbus signal index
value	int	0	Output when the type is DR_MODBUS_DIG_OUTPUT or DR_MODBUS_REG_OUTPUT (ignored otherwise)
slaveid	int	255	<ul style="list-style-type: none"> • Slave ID of the ModbusTCP module (0 or 1-247 or 255) 0 : Broadcast address 255 : Default value for ModbusTCP

Note

- The slaveid argument is only available in M2.40 and later versions.

Functions

▪ **Return**

Value	Description
0	Success
Negative value	Failed

▪ **Exception**

Exception	Description
DR_Error (DR_ERROR_TYPE)	Parameter data type error occurred
DR_Error (DR_ERROR_VALUE)	Parameter value is invalid
DR_Error (DR_ERROR_RUNTIME)	C extension module error occurred
DR_Error (DR_ERROR_STOP)	Program terminated forcefully

▪ **Example**

```
# An example of connecting two Modbus IO and allocating the contacts
#Modbus IO 1: IP 192.168.127.254, 8 input points: "di1" - "di8", 8 output points: "do1" -
"do8"
#Modbus IO 2: IP 192.168.127.253, 8 input points: "di9" - "di16", 8 output points: "do9" -
"do16"
```

```
# set <modbus 1> input : di1~di8
add_modbus_signal(ip="192.168.127.254",port=502, name="di1",
reg_type=DR_MODBUS_REG_INPUT, index=0)
add_modbus_signal(ip="192.168.127.254",port=502, name="di2",
reg_type=DR_MODBUS_REG_INPUT, index=1)
add_modbus_signal(ip="192.168.127.254",port=502, name="di3",
reg_type=DR_MODBUS_REG_INPUT, index=2)
add_modbus_signal(ip="192.168.127.254",port=502, name="di4",
reg_type=DR_MODBUS_REG_INPUT, index=3)
add_modbus_signal(ip="192.168.127.254",port=502, name="di5",
reg_type=DR_MODBUS_REG_INPUT, index=4)
add_modbus_signal(ip="192.168.127.254",port=502, name="di6",
reg_type=DR_MODBUS_REG_INPUT, index=5)
add_modbus_signal(ip="192.168.127.254",port=502, name="di7",
reg_type=DR_MODBUS_REG_INPUT, index=6)
add_modbus_signal(ip="192.168.127.254",port=502, name="di8",
reg_type=DR_MODBUS_REG_INPUT, index=7)
```

```
# set <modbus 1> output : do1~do8
add_modbus_signal(ip="192.168.127.254",port=502, name="do1",
```



Functions

```
reg_type=DR_MODBUS_REG_OUTPUT, index=0, value=0)
add_modbus_signal(ip="192.168.127.254",port=502, name="do2",
reg_type=DR_MODBUS_REG_OUTPUT, index=1, value=0)
add_modbus_signal(ip="192.168.127.254",port=502, name="do3",
reg_type=DR_MODBUS_REG_OUTPUT, index=2, value=0)
add_modbus_signal(ip="192.168.127.254",port=502, name="do4",
reg_type=DR_MODBUS_REG_OUTPUT, index=3, value=0)
add_modbus_signal(ip="192.168.127.254",port=502, name="do5",
reg_type=DR_MODBUS_REG_OUTPUT, index=4, value=0)
add_modbus_signal(ip="192.168.127.254",port=502, name="do6",
reg_type=DR_MODBUS_REG_OUTPUT, index=5, value=0)
add_modbus_signal(ip="192.168.127.254",port=502, name="do7",
reg_type=DR_MODBUS_REG_OUTPUT, index=6, value=0)
add_modbus_signal(ip="192.168.127.254",port=502, name="do8",
reg_type=DR_MODBUS_REG_OUTPUT, index=7, value=0)

#=====
# set <modbus 2> input : di9~di16
add_modbus_signal(ip="192.168.127.253",port=502, name="di9",
reg_type=DR_MODBUS_REG_INPUT, index=0)
add_modbus_signal(ip="192.168.127.253",port=502, name="di10",
reg_type=DR_MODBUS_REG_INPUT, index=1)
add_modbus_signal(ip="192.168.127.253",port=502, name="di11",
reg_type=DR_MODBUS_REG_INPUT, index=2)
add_modbus_signal(ip="192.168.127.253",port=502, name="di12",
reg_type=DR_MODBUS_REG_INPUT, index=3)
add_modbus_signal(ip="192.168.127.253",port=502, name="di13",
reg_type=DR_MODBUS_REG_INPUT, index=4)
add_modbus_signal(ip="192.168.127.253",port=502, name="di14",
reg_type=DR_MODBUS_REG_INPUT, index=5)
add_modbus_signal(ip="192.168.127.253",port=502, name="di15",
reg_type=DR_MODBUS_REG_INPUT, index=6)
add_modbus_signal(ip="192.168.127.253",port=502, name="di16",
reg_type=DR_MODBUS_REG_INPUT, index=7)

# set <modbus 2> output : do9~do16
add_modbus_signal(ip="192.168.127.253",port=502, name="do9",
reg_type=DR_MODBUS_REG_OUTPUT, index=0, value=0)
add_modbus_signal(ip="192.168.127.253",port=502, name="do10",
reg_type=DR_MODBUS_REG_OUTPUT, index=1, value=0)
add_modbus_signal(ip="192.168.127.253",port=502, name="do11",
reg_type=DR_MODBUS_REG_OUTPUT, index=2, value=0)
add_modbus_signal(ip="192.168.127.253",port=502, name="do12",
reg_type=DR_MODBUS_REG_OUTPUT, index=3, value=0)
add_modbus_signal(ip="192.168.127.253",port=502, name="do13",
reg_type=DR_MODBUS_REG_OUTPUT, index=4, value=0)
add_modbus_signal(ip="192.168.127.253",port=502, name="do14",
reg_type=DR_MODBUS_REG_OUTPUT, index=5, value=0)
add_modbus_signal(ip="192.168.127.253",port=502, name="do15",
```



Functions

```
reg_type=DR_MODBUS_REG_OUTPUT, index=6, value=0)
add_modbus_signal(ip="192.168.127.253",port=502, name="do16",
reg_type=DR_MODBUS_REG_OUTPUT, index=7, value=0)
```



Functions

13.1.2 del_modbus_signal (name)

▪ **Features**

This function deletes the registered Modbus signal. The Modbus I/O must be set in the Teach Pendant I/O set-up menu. Use this command only for testing if it is difficult to use the Teach Pendant. The Modbus menu is disabled in the Teach Pendant if it is set using this command.

▪ **Parameters**

Parameter Name	Data Type	Default Value	Description
name	string	-	Name of the registered Modbus signal

▪ **Return**

Value	Description
0	Success
Negative value	Failed

▪ **Exception**

Exception	Description
DR_Error (DR_ERROR_TYPE)	Parameter data type error occurred
DR_Error (DR_ERROR_VALUE)	Parameter value is invalid
DR_Error (DR_ERROR_RUNTIME)	C extension module error occurred
DR_Error (DR_ERROR_STOP)	Program terminated forcefully

▪ **Example**

```
# Use the following command when the Modbus IO signals are registered as "di1" and "do1"
# and this signal registration is to be deleted.
del_modbus_signal("di1")      # Deletes the registered "di1" contact
del_modbus_signal("do1")     # Deletes the registered "do1" contact
```

Functions

13.1.3 set_modbus_output(iobus, val)
▪ Features

This function sends the signal to an external Modbus system.

▪ Parameters

Parameter Name	Data Type	Default Value	Description
iobus	string	-	Modbus name (set in the TP)
value	int	-	Modbus digital I/O <ul style="list-style-type: none"> • ON : 1 • OFF : 0
			Value for Modbus analog I/O

▪ Return

Value	Description
0	Success
Negative value	Failed

▪ Exception

Exception	Description
DR_Error (DR_ERROR_TYPE)	Parameter data type error occurred
DR_Error (DR_ERROR_VALUE)	Parameter value is invalid
DR_Error (DR_ERROR_RUNTIME)	C extension module error occurred
DR_Error (DR_ERROR_STOP)	Program terminated forcefully

▪ Example

```
#Modbus digital I/O is connected, and the signals are registered as "do1" and "do2".
set_modbus_output("do1", ON)
set_modbus_output("do2", OFF)
```

```
#Modbus analog I/O is connected, and the signals are registered as "reg1" and "reg2".
set_modbus_output("reg1", 10)
set_modbus_output("reg2", 24)
```



Functions

13.1.4 get_modbus_input(iobus)

▪ **Features**

This function reads the signal from the Modbus system.

▪ **Parameters**

Parameter Name	Data Type	Default Value	Description
iobus	string	-	Modbus name (set in the TP)

▪ **Return**

Value	Description
0 or 1	ON or Off in the case of the Modbus digital I/O
value	The register value in the case of the Modbus analog module

▪ **Exception**

Exception	Description
DR_Error (DR_ERROR_TYPE)	Parameter data type error occurred
DR_Error (DR_ERROR_VALUE)	Parameter value is invalid
DR_Error (DR_ERROR_RUNTIME)	C extension module error occurred
DR_Error (DR_ERROR_STOP)	Program terminated forcefully

▪ **Example**

```
#Modbus digital I/O is connected, and the signals are registered as "di1" and "di2".
get_modbus_input("di1")
get_modbus_input("di2")
#Modbus analog I/O is connected, and the signals are registered as "reg1" and "reg2".
get_modbus_input("reg1")
get_modbus_input("reg2")
```



Doosan Robotics

www.doosanrobotics.com